

# TC.ACS.50.528.4WR.HC.LC

## Programmable Regenerative AC Power Supply

V02.50



### Features

#### Scope of Application

The increasing number of alternative power sources like solar, wind driven or biological energy systems call for consistent and well demanding regulations for energy feed into the utility grid. Manufacturers of such systems have to test and to prove the compliance of their equipment.

REGATRON TC.ACS represents the newest generation of fully programmable, regenerative grid simulation systems. Modular architecture and additional operation modes make them an ideal choice for test and R+D laboratories.

#### TC.ACS - Main Features

- Each phase individually programmable
- Variation of fundamental frequencies up to 1000 Hz
- Variation/modulation of phase angles, amplitudes and frequency
- Voltage drops either three phase or each single phase
- Asymmetric three phase voltages
- Micro-ruptures and flicker
- Periodic and single shot under- and over-voltages
- Superimposed harmonic and inter-harmonic voltages up to 5 kHz
- Simulation of a real AC grid with Grid and Grid Impedance Simulation
- Test Suite for EMC Testing according IEC/EN 61000-3-x/-4-x
- Load Simulation with RLC Load Mode or Power Mode

#### The Grid Simulation System as a Building Block of a Complete Test Environment

Owing to the regenerative capability of the TC.ACS system, almost all AC power equipment can be tested with the appropriate test procedures. An integrated test environment for solar inverters is composed of a Solar Array Simulation block (SAS), the device under test (DUT) and the grid simulator system (ACS). While the REGATRON SAS components allow for precise simulation of a user-defined solar array of any order under arbitrary conditions, the ACS simultaneously defines the different test conditions with respect to the grid connection. Depending on the requirements, the ACS functionality may be tailored with various software options. In addition to the *Basic Waveform Generator Mode* and the *Amplifier Mode*, which are within the standard scope of delivery, the options *Full Waveform Generator Mode* with *Fourier Synthesis Tool* as well as *Datapoint Waveform Tool*, *Current controlled Amplifier Mode*, *Power Mode*, *Grid Impedance Simulation* and *Load Simulation Mode* are available.

#### Software

##### Grid Simulation

An intuitive application based software with various options allows for manual operation, programming and for automated test runs. With the optional *Full Waveform Generator Mode* (GridSim) a set of predefined voltage shapes – sine, cut sine, square, triangle, sawtooth, user defined - facilitates a quick and easy definition of specific grid situations. This software option also offers freely programmable modulations on each phase for amplitude, frequency and phase angle.

The combination of the two simulations grid impedance (*Grid Impedance Simulation*) and grid (*GridSim*) provides the possibility to emulate the behavior of a real AC grid and is a valuable tool for testing objects under real conditions.

#### Software (continued)

##### Load Simulation

The *Power Mode* extends the existing *Load Simulation Mode* and offers the user the option of specifying the target values of apparent power, power factor  $\cos(\varphi)$  or alternatively the active and reactive power inductively or capacitively. The current or voltage is controlled in order to keep the selected power and the phase shift between voltage and current constant.

##### Hardware

REGATRON grid simulator systems use a state of the art multilevel double inverter technology. The main advantages over existing linear power supplies are a substantial reduction of power losses, regenerative operation, very compact power units and the modular, cost-effective architecture. This allows the user to choose a system size that meets their requirements, including the possibility for future power expansions and/or splitting-up of the system into several stand-alone subsystems. The basic triphase power units of 30 kVA or 50 kVA may be expanded by simply paralleling further blocks even to big systems reaching 2000+ kVA.

With the availability of the active neutral string, any single phase or asymmetric condition can be simulated. Additionally, the neutral can be connected to Protective Earth (PE), if required.

The system will allow for all relevant testing according to the grid-feed-in regulations (CENELEC, DIN, IEC). Note the operation as a grid simulator, as triphase regenerative voltage amplifier and as a programmable electronic load are possible.

#### Application Example

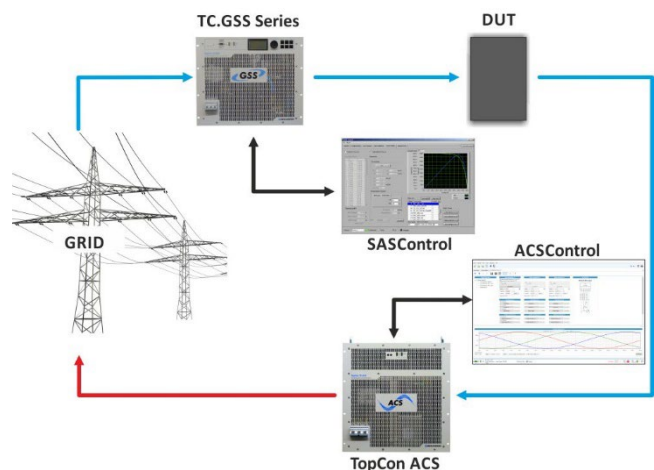

By the addition of a bidirectional regenerative DC power supply TC.GSS or G5 to such a test environment, even the role of an energy storage pack within the setup may be experienced.

REGATRON offers complete and modular SAS systems based on the widespread, field-proven TopCon Quadro and the G5 power supplies on one hand as well as complete grid simulation on the other hand. Modern switched-mode technology ensures very compact and reliable systems with high overall efficiency.

## Technical Data

### Key Values

Programmable Regenerative AC Power Supply	
Power range	0...50 kVA
Voltage range	3 x 0...305 V <sub>RMS</sub> (L-N)
Current range	3 x 0...75 A <sub>RMS</sub>
Master-slave / multi-device configuration	parallel
Max. number of devices in system	up to 50
Case	19" / 11U

### AC Lineside Ratings (X10)

<b>Mains connection</b>	
Mains connection type	3L + PE (no neutral)
Line voltage	3 x 360...528 V <sub>RMS</sub>
Input current	3 x 380 V <sub>RMS</sub> / 85 A <sub>RMS</sub>
	3 x 400 V <sub>RMS</sub> / 81 A <sub>RMS</sub>
	3 x 415 V <sub>RMS</sub> / 78 A <sub>RMS</sub>
	3 x 440 V <sub>RMS</sub> / 74 A <sub>RMS</sub>
	3 x 460 V <sub>RMS</sub> / 71 A <sub>RMS</sub>
	3 x 480 V <sub>RMS</sub> / 68 A <sub>RMS</sub>
Line frequency	48...62 Hz
Powerfactor @nominal power	1
Precharge unit provided. No excessive inrush current.	
THDi @90% P <sub>max</sub>	<1%
Input filter discharge to <60 V	<20 s
	with option XCD <1 s

### Isolation

Working voltage	line L1, L2, L3 to PE	305 V <sub>RMS</sub>
Working voltage	line L1, L2, L3 to PE	432 V <sub>DC</sub>
Test voltage	line L1, L2, L3 to PE	2120 V <sub>DC</sub> / 1 s

### Loadside Ratings (X20)

#### Voltage controlled (CV) Mode

AC voltage operating range per phase	0...305 V <sub>RMS</sub> (L-N)
DC voltage operating range per phase	0...415 V <sub>DC</sub>
Static accuracy RMS-controller	≤0.05% FS
Static accuracy general	≤1.5 V
Slew rate	≤4 V/μs
Step 10%...90% FS (see Figure 8)	≤100 μs
Settling time @step 0...90% FS, error band ≤2% FS	≤300 μs
Voltage drop @full load step	≤100 V

#### Current controlled (CC) Mode

AC current operating range per phase	3...72 A <sub>RMS</sub>
DC current operating range per phase	3...20 A <sub>DC</sub>
Static accuracy general @0...500 Hz	≤2 A
Static accuracy general @500...1000 Hz	≤3 A
Slew rate	≤0.32 A/μs
Step 10%...90% step FS (see Figure 8)	≤180 μs
Settling time @step 0...90% FS, error band ≤2% FS	≤400 μs

#### Power controlled (CS/CP) Mode

AC power operating range per phase @230 V <sub>RMS</sub> <sup>1)</sup>	0.7...16.67 kVA
Static accuracy general @1...500 Hz	≤0.3 kVA
Static accuracy general @500...1000 Hz	≤0.45 kVA
Slew rate @230 V <sub>RMS</sub>	≤70 VA/μs
Step 10%...90% FS @230 V <sub>RMS</sub> (see Figure 8)	≤180 μs
Settling time @step 0...90% FS, error band ≤2% FS @230 V <sub>RMS</sub>	≤400 μs

### Loadside Ratings (X20, continued)

Frequency range (see Figure 2 to 4)	0...1000 Hz
Modulation bandwidth	5000 Hz
DC offset	≤10 mV
Efficiency @nominal power	90%
Output filter capacitance (L-N)	24.7 μF

### Static Accuracy

Frequency	2 mHz
Phase Angle	1°

### Measurement Precision

Voltage	±0.7% FS
Current	±1.4% FS

### Setpoint Resolution

Voltage	0.1 V
Frequency	1 mHz
Phase	0.1°

### Overloadability (see Figure 3 to 7)

Up to 10 s every 600 s	≤150%
Up to 1 s every 60 s	≤200%

### DC ripple + noise

16 Hz...200 kHz	230 mV <sub>RMS</sub>
9 kHz...20 MHz	700 mV <sub>PP</sub>

### Harmonic distortion @50 Hz (THDu)<sup>3)</sup>

Linear loads	≤0.4%
Non linear loads	≤1.6%

### Isolation

Working voltage	output L1, L2, L3 to PE	305 V <sub>RMS</sub>
Working voltage	output L1, L2, L3 to PE	432 V <sub>DC</sub>
Test voltage	output L1, L2, L3 to PE	2120 V <sub>DC</sub> / 1 s

### Grid Impedance Simulation

AC voltage operating range per phase	0...305 V <sub>RMS</sub> (L-N)
DC voltage operating range per phase	0...415 V <sub>DC</sub>
Frequency operating range for voltage and current	0...100 Hz
Modulation bandwidth for voltage and current	0...100 Hz
Static accuracy @standard impedance values <sup>2)</sup> (phase: 0.24 Ω, 477 μH; neutral: 0.16 Ω, 159 μH)	
Voltage (U) @50/60 Hz	≤0.7% @f <sub>c</sub> = 500 Hz ≤0.7% @f <sub>c</sub> = 700 Hz
Resistance (R) @50/60 Hz	≤8% @f <sub>c</sub> = 500 Hz ≤6% @f <sub>c</sub> = 700 Hz
Inductivity (L) @50/60 Hz	≤19% @f <sub>c</sub> = 500 Hz ≤14% @f <sub>c</sub> = 700 Hz
Voltage (U) @100 Hz	≤0.7% @f <sub>c</sub> = 500 Hz ≤0.7% @f <sub>c</sub> = 700 Hz
Resistance (R) @100 Hz	≤22% @f <sub>c</sub> = 500 Hz ≤17% @f <sub>c</sub> = 700 Hz
Inductivity (L) @100 Hz	≤21% @f <sub>c</sub> = 500 Hz ≤15% @f <sub>c</sub> = 700 Hz

1) The minimum power is calculated from the minimum CC limit (3 A) and the actual voltage

2) Static accuracy depends on the parameters used for the grid impedance simulation and the type of test object

3) Up to 290 V<sub>RMS</sub> (L-N)

## Technical Data (continued)

### AC Loadside Ratings (X20)

Phase Connection '3L (AC/DC)': 3L + N (see Figure 3, 5, 9)	
Power range	0...50 kVA
Voltage range	3 x 0...305 V <sub>RMS</sub> (L-N)
Connection type	3L + N + PE
Current range 3Φ	3 x 0...75 A <sub>RMS</sub> <sup>1)2)</sup>
Current range 1Φ	1 x 0...80 A <sub>RMS</sub> <sup>6)</sup>

Phase Connection '1L (AC/DC double current)': 1L + N (see Figure 4, 6, 10)	
Power range	0...20 kVA <sup>3)</sup>
Voltage range	0...305 V <sub>RMS</sub> (L-N)
Connection type	L1//L2 + L3//N + PE
Current range 1Φ	0...150 A <sub>RMS</sub> <sup>1)</sup>

Phase Connection '2L (AC/DC double voltage/current)': 2L (see Figure 4, 7, 11)	
Power range	0...50 kVA
Voltage range	0...610 V <sub>RMS</sub> (L-L)
Connection type	L1//L2 + L3//N + PE
Current range 1Φ	0...150 A <sub>RMS</sub> <sup>1)</sup>

### DC Loadside Ratings (X20)

Phase Connection '2L (AC/DC double voltage/current)': 1 output (symmetric to PE)	
Power range	0...±33 kW
Voltage range	0...±830 V <sub>DC</sub>
Connection type	L1//L2 + L3//N
Current range	0...±40 A <sub>DC</sub>

Phase Connection '1L (DC triple current)': 1 output (related to PE)	
Power range	0...±25 kW
Voltage range	0...±415 V <sub>DC</sub>
Connection type	L1//L2//L3 + N
Current range	0...±60 A <sub>DC</sub>

Phase Connection '3L (AC/DC)': 2 independent outputs	
Power range	0...±16 kW
Voltage range	0...±830 V <sub>DC</sub>
Connection type	L1 + L2
Current range	0...±20 A <sub>DC</sub> <sup>4)</sup>
Power range	0...±8 kW
Voltage range	0...±415 V <sub>DC</sub>
Connection type	L3 + N
Current range	0...±20 A <sub>DC</sub> <sup>4)</sup>

Phase Connection '3L (AC/DC)': 3 independent outputs (related to PE)	
Power range	3 x 0...±8 kW
Voltage range	3 x 0...±415 V <sub>DC</sub>
Connection type	L1 + N / L2 + N / L3 + N
Current range	3 x 0...±20 A <sub>DC</sub> <sup>4)</sup>

### Protection

Built-in Protection	
Overvoltage protection	programmable
Overcurrent protection	programmable

**Internal diagnostics**  
Line input conditions, internal current conditions, temperature conditions, system configuration, system communication, power semiconductor temperatures.

Type of Protection (according EN 60529)	
Basic construction	IP 20
Mounted in cabinet	up to IP 54 <sup>5)</sup>

**Load side**  
Over voltage category (according to EN 62477-1) **1**  
NOTE: If overvoltage category 1 in accordance with EN 62477-1 cannot be met, surge protective devices (SPDs), inductors or transformers must be installed.

Safety Interface	
<b>ISR (integrated safety relay)</b>	
2-channel (2 x category 1, PL c according DIN EN ISO 13849-1:2015)	
Read-back circuit with forcibly guided contacts	
PL e possible with 2-channel and external safety relay (optional)	

I/O Interfaces	
<b>Control Port Input Functions (X610 – X612)</b>	
Amplifier mode @scaling factor 1:	
Voltage setting L1: -432 V...+432 V	-10...+10 V
Voltage setting L2: -432 V...+432 V	-10...+10 V
Voltage setting L3: -432 V...+432 V	-10...+10 V
Current setting L1: -204 A...+204 A	-10...+10 V
Current setting L2: -204 A...+204 A	-10...+10 V
Current setting L3: -204 A...+204 A	-10...+10 V
Maximum input voltage	±30 V
Sampling rate	80 kHz
Time delay input to output	<70 μs
Isolation to electronics and earth	125 V <sub>RMS</sub>
Input impedance	20.5 kΩ

Trigger ports BNC	
Trigger Input X620 (Start)	TTL
Input impedance	10 kΩ
Trigger Output X621 (programmable)	TTL
Output impedance	560 Ω (short-circuit-proof)
Isolation to electronics and earth	250 V <sub>RMS</sub>

Analog port 12-pin flush-type (X609)	
4 Inputs for general usage	±9.5 V reference voltage
4 Outputs for general usage	±9.5 V reference voltage
Time delay power output to analog output	<50 μs
Output pins min. load impedance	2 kΩ
Input pins input impedance	330 kΩ
Sampling rate	80 kHz
Isolation to electronics and earth	250 V <sub>RMS</sub>

1) Current according to the given power limit of the corresponding units  
 2) Only in CV mode, in CC mode max. 3 x 0...72 A<sub>RMS</sub>  
 3) Power reduction due to internal limitations  
 4) Total current in N is limited to 20A  
 5) Slight temperature derating possible depending on ambient temperature inside cabinet.

6) The 80 A 2-phase (or split-phase 120 V<sub>AC</sub> - Neutral - 120 V<sub>AC</sub>) can be supported with the following restrictions:  
 - No other phases under load  
 - Ambient temperature <25 °C  
 - The specified overloadability cannot be guaranteed.

## Technical Data (continued)

### Communication Interfaces

#### USB Type B (X607)

Integrated interface for remote control with the operation software ACSControl/API	
Isolation to electronics and earth	250 V <sub>RMS</sub>

#### Ethernet (X605)

Integrated interface for remote control with the operation software ACSControl/API	
Isolation to electronics and earth	200 V <sub>RMS</sub>

#### RS232 (X606)

Service interface	
Isolation to electronics and earth	125 V <sub>RMS</sub>

## General Data

### Weight & Dimension (see Figure 1)

Weight	150 kg / 331 lbs
Width housing	444 mm / 17 ½"
Height housing	489 mm / 19 ¼"
Depth with output terminals	635 mm / 25"

### Terminals

Screw terminals for 6...35mm <sup>2</sup> wires	d ≤ 8.5mm
AC lineside terminals	3L + PE
AC loadside terminals	3L + N + PE

### Ambient

Operating temperature	5...40 °C
Storage temperature	-18...70 °C
Relative air humidity (non-condensing)	0...95%
Installation altitude	0...2000 m above sea level <sup>1)</sup>
Installation	in 19" switch cabinet
	IEC 60721-3-3 indoor, air-conditioned
Vibration	IEC 60068-2-6 Test Fc
Operating orientation	upright
Storage, transport orientation	upright
Acoustic noise level	≤ 74 dB @ 1 m

### Liquid Cooling (LC) Specifications

#### (Air-cooling possible with optional TC.LAE)

Material	Al
Inlet/outlet on rear side size	G ½"
Liquid temperature inlet (non-condensing)	15...50 °C
Minimum flow rate	2.5 l/min
Recommended flow rate	5 l/min
Maximum inlet temperature	25 °C @ 2.5 l/min 40 °C @ 5 l/min 50 °C @ 8 l/min
Operation pressure max.	4 bar
Pressure drop	70 mbar @ 5 l/min
Use cooling liquid with a 30% share of Antifrogen N® within a closed circuit	

### Standards

Protection class	I
Overvoltage category according to IEC 60664-1	
Line to Line	II
Line to PE	III
Degree of pollution	2
Area of application	industrial

### Approval CE

Low Voltage Directive 2014/35/EU	EN 62477-1:2012 + A11 :2014 + A1 :2017 + A12 :2021
EMC Directive 2014/30/EU	
EMC immunity (industrial)	EN 61000-6-2:2005
EMC emission (industrial)	EN 61000-6-4:2007 + A1:2011
RoHS Directive 2011/65/EU	EN IEC 63000:2018

### Approval UKCA

Electrical Equipment (Safety) Regulations 2016	BS EN 62477-1:2012 + A11 :2014 + A1 :2017 + A12 :2021
Electromagnetic Compatibility Regulations 2016	
EMC immunity (industrial)	BS EN 61000-6-2:2005
EMC emission (industrial)	BS EN 61000-6-4:2007 + A1:2011
The Restriction of the Use of Certain Hazardous Substances in Electrical and Electronic Equipment Regulations 2012	BS EN IEC 63000:2018

Sales Partner:



**ABSOLUTE EMC** Llc.  
Covering sales in North America  
United States, Mexico, & Canada

absolute-emc.com  
Phone: 703-774-7505  
info@absolute-emc.com

1) Above 1000 m, slight temperature derating possible

## User Software

### Application Software ACSControl



## Software Options

### ACSControl integrated

Full Waveform Generator Mode (Phase Connections included)	GridSim
Grid Impedance Simulation	Grid Impedance Simulation
AC Load Simulation Mode	RLC-Load Mode
Power Controlled (CS/CP) Mode	Power Mode
Current Controlled Mode	Current Control Mode
Phase Connections (available in CV Mode only):	Phase Connections
1L (AC/DC double current)	
2L (AC/DC double voltage/current)	
1L (DC triple current)	

### EMC Test Sequences, preprogrammed:

IEC/EN 61000-3-2	IEC/EN 61000-4-11
IEC/EN 61000-3-3	IEC/EN 61000-4-13
IEC/EN 61000-3-11	IEC/EN 61000-4-14
IEC/EN 61000-3-12	IEC/EN 61000-4-27
	IEC/EN 61000-4-28
	IEC/EN 61000-4-34

## Hardware Options

### Senseboard for RMS voltage drop compensation

With programmable transformer ratio

#### 1500 V type, maximum input voltages:

L-L, L-N, L-PE:	1000 V <sub>RMS</sub> , 1500 V <sub>p</sub>
N-PE:	500 V <sub>RMS</sub> , 750 V <sub>p</sub>

#### 750 V type, maximum input voltages:

L-L:	860 V <sub>RMS</sub> , 1290 V <sub>p</sub>
L-N:	500 V <sub>RMS</sub> , 750 V <sub>p</sub>
N-PE:	500 V <sub>RMS</sub> , 750 V <sub>p</sub>

#### 500 V type, maximum input voltages:

L-L:	570 V <sub>RMS</sub> , 860 V <sub>p</sub>
L-N:	330 V <sub>RMS</sub> , 500 V <sub>p</sub>
N-PE:	500 V <sub>RMS</sub> , 750 V <sub>p</sub>

### Digital I/O Interface

8 x Digital IN	24 V <sub>DC</sub>
8 x Digital OUT	24 V <sub>DC</sub>
4 x Relays	potential free SPDT

### TC.ACS X609 Adapter (Analog I/O Adapter)

4 x Analog IN	±9.5 V <sub>DC</sub>
4 x Analog OUT	±9.5 V <sub>DC</sub>

### TC.ACS.CANmp Interface

2 x D-Sub 9 pin male connector	CAN interface
8 x Digital IN	24 V <sub>DC</sub>
8 x Digital OUT	24 V <sub>DC</sub>

### Air Cooling

#### External Liquid to Air Heat Exchanger (TC.LAE)<sup>1)</sup>

In addition to the internal Liquid Cooling (LC)

Max. Power @40 °C ambient temperature	35 kVA
Max. Power @35 °C ambient temperature	45 kVA
Max. Power @32 °C ambient temperature	50 kVA

## Dimensions

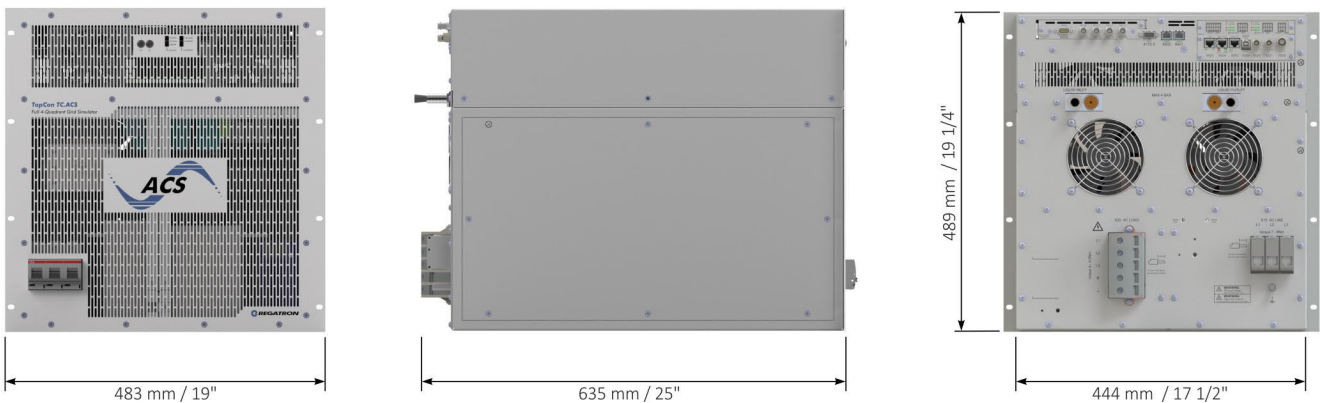

Figure 1: Front, right hand side and rear view. 19-inch module with 11 units in height.

Sales Partner:



**ABSOLUTE EMC** Lic.  
Covering sales in North America  
United States, Mexico, & Canada

absolute-emc.com  
Phone:703-774-7505  
info@absolute-emc.com

1) Derating of Power depending on the ambient temperature so that the coolant inlet temperature <50 °C.

Further Description Details

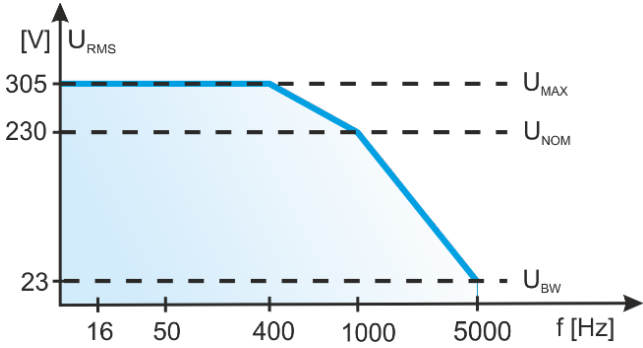

Figure 2: Output voltage vs. frequency

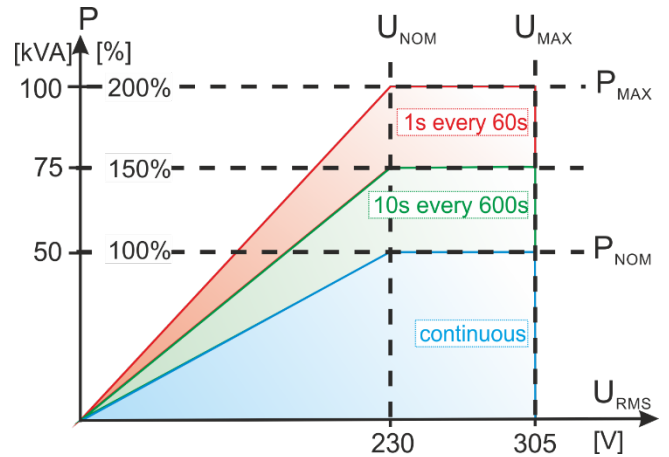

Figure 5: Overloadability vs. voltage (Phase Connection '3L (AC/DC)')

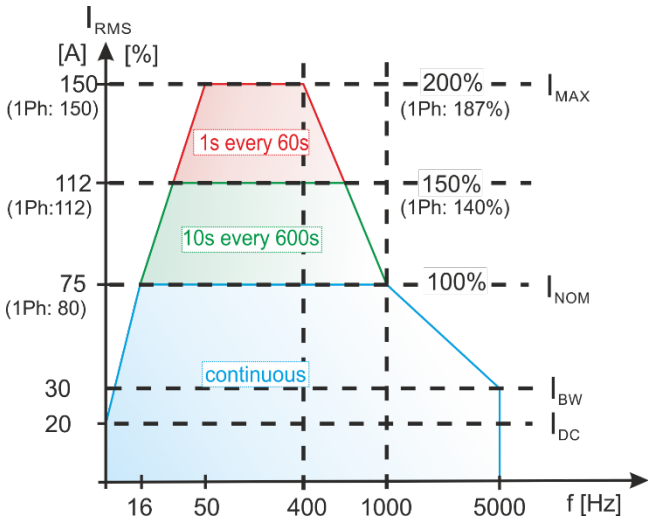

Figure 3: Overloadability vs. frequency (Phase Connection '3L (AC/DC)')

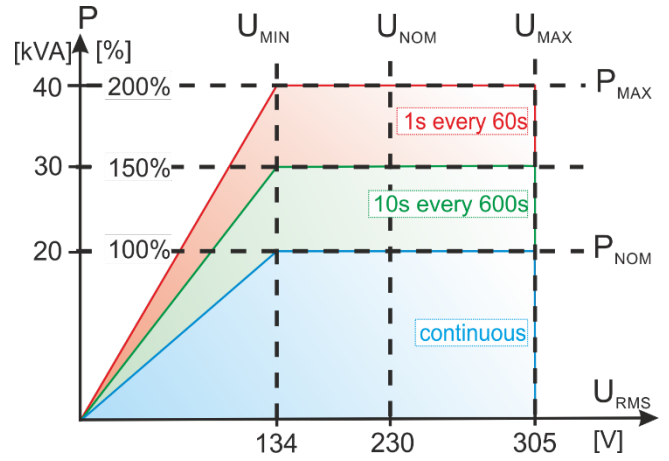

Figure 6: Overloadability vs. voltage (Phase Connection '1L (AC/DC double current)')

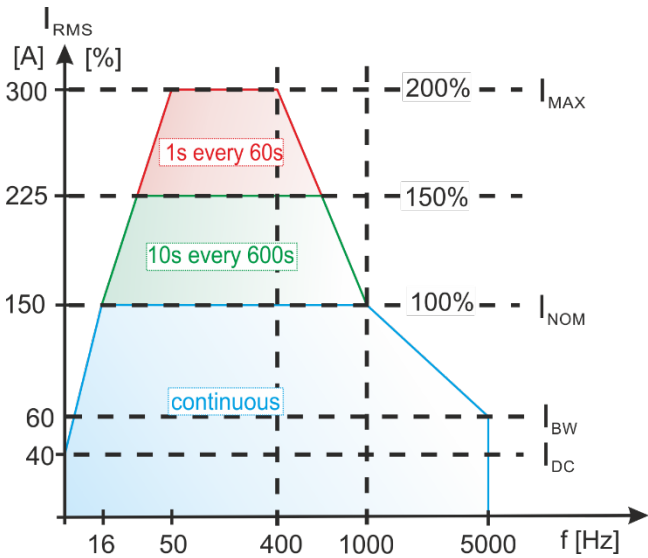

Figure 4: Overloadability vs. frequency (Phase Connection '1L (AC/DC double current)' and Phase Connection '2L (AC/DC double voltage/current)')

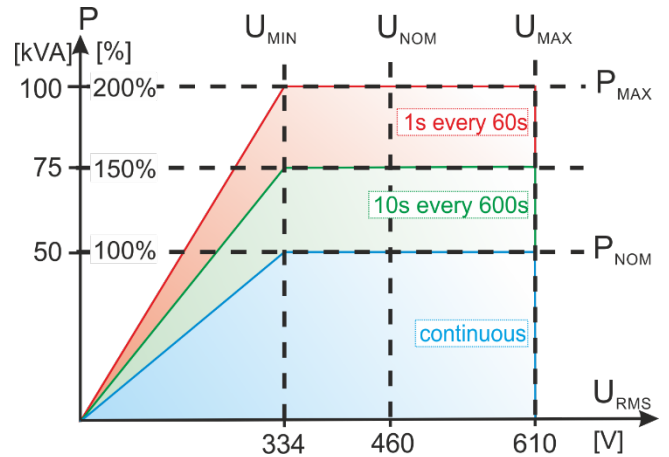

Figure 7: Overloadability vs. voltage (Phase Connection '2L (AC/DC double voltage/current)')

Further Description Details (continued)

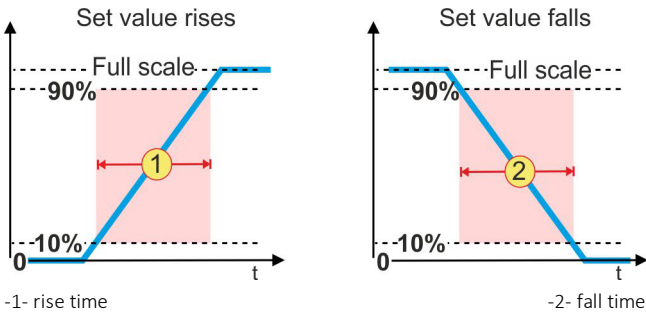

Figure 8: Step 10...90% CV, CC, CS/CP

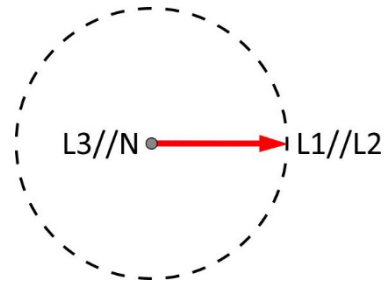
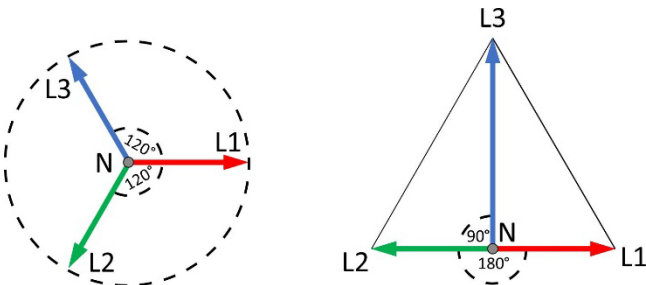

Figure 10: Phase Connection '1L (AC/DC double current)'



any independent phase angle possible, including split phase

Figure 9: Phase Connection '3L (AC/DC)'

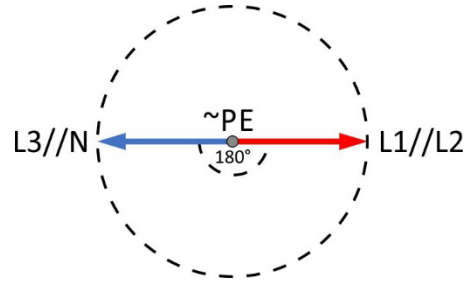

Figure 11: Phase Connection '2L (AC/DC double voltage/current)'

This product is developed, produced and tested according to ISO 9001 by REGATRON.

For detailed technical information, contact your local sales partner or REGATRON.

REGATRON AG Feldmuehlestrasse 50 9400 Rorschach SWITZERLAND sales@regatron.com www.regatron.com	REGATRON Inc. 100 Overlook Center, 2 <sup>nd</sup> Floor Princeton, NJ 08540 USA inquiries@us.regatron.com www.us.regatron.com
--	---

All product specifications and information contained herein are subject to change without notice.

Filename: DS\_TC.ACS.50.528.4WR.HC.LC\_EN\_V02.50

Class: Project specific use only

Sales Partner:



**ABSOLUTE EMC** Llc.  
Covering sales in North America  
United States, Mexico, & Canada

absolute-emc.com  
Phone: 703-774-7505  
info@absolute-emc.com