

# Modulated Wideband Power Amplifier

## 1 Introduction

The TBMDA3B, 10MHz – 1 GHz modulated wideband power amplifier is designed to provide a low-cost RF power source for pre-compliance immunity testing of electronic building blocks and products. Driven with an input power of less than 0 dBm, it can deliver a saturated output power of up to 8 W. The TBMDA3 is ideal to drive Tekbox near field probes in order to find the sensitive spot of electronic circuits, or to generate strong electric fields for radiated immunity testing in TEM cells. It can generate up to 700V/m when driving the Tekbox TEM Cell TBTC0, 400V/m when driving the TBTC1, 200V/m when driving the TBTC2, or 130V/m when driving the TBTC3.

A built in AM- modulator enables the use of tracking generators as signal source. The TBMDA3B has sufficient gain to achieve its maximum output power when driven with the tracking generator of a spectrum analyzer. Besides 1 kHz, 80% AM, the TBMDA3B provides built in modulation capability to generate 1 kHz, 50% duty cycle PM signals. In PM mode, the TBMDA3B can also generate a 217 Hz Signal with 12.5% duty cycle in order to simulate mobile phone TDMA noise.



Picture 1 – TBMDA3B modulated wideband driver amplifier, front view



Picture 2 – TBMDA3B modulated wideband driver amplifier, rear view

Sales Partner:



ABSOLUTE EMC Lic.  
Covering sales in North America  
United States, Mexico, & Canada

absolute-emc.com  
Phone:703-774-7505  
info@absolute-emc.com

# Modulated Wideband Power Amplifier

## **Application:**

Wideband RF power amplifier for conducted immunity testing driving CDNs or BCI-probes

Wideband RF power amplifier for radiated immunity testing, driving near field probes

Wideband RF power amplifier for radiated immunity testing, driving TEM Cells

## **Features:**

CW amplifier (modulation off)

1 kHz, 80% AM modulation

1 kHz, 50% duty cycle pulse modulation

217 Hz, 12.5% duty cycle pulse modulation

## 2 Electrical Specifications

### **Technical Data:**

Input / Output: 50 Ohm, N female

Supply Voltage range: 110 V...240 V

Supply power consumption: 25 W @ 220V

Operating temperature range: -20°C to 50°C

Frequency range: 10 MHz – 1 GHz, usable from 5 MHz to 1.1 GHz

Small signal gain: 42 dB typ.

Gain flatness 10 MHz – 1 GHz / Pin = -15 dBm: 2 dB typ.

Saturated output power @ 5 MHz / Pin = 0 dBm: 39.1 dBm (8.1 W) typ.

Saturated output power @ 10 MHz / Pin = 0 dBm: 39.3 dBm (8.5 W) typ.

Saturated output power @ 50 MHz / Pin = 0 dBm: 39.7 dBm (9.3 W) typ.

Saturated output power @ 75 MHz / Pin = 0 dBm: 39.7 dBm (9.4 W) typ.

Saturated output power @ 100 MHz / Pin = 0 dBm: 39.7 dBm (9.4 W) typ.

Saturated output power @ 250 MHz / Pin = 0 dBm: 40.5 dBm (11.2 W) typ.

Saturated output power @ 500 MHz / Pin = 0 dBm: 40.5 dBm (11.3 W) typ.

Saturated output power @ 750 MHz / Pin = 0 dBm: 39.5 dBm (8.8 W) typ.

Saturated output power @ 1000 MHz / Pin = 0 dBm: 39.8 dBm (9.6 W) typ.

Saturated output power @ 1100 MHz / Pin = 0 dBm: 38.7 dBm (7.3 W) typ.

Sales Partner:



ABSOLUTE EMC Lic.  
Covering sales in North America  
United States, Mexico, & Canada

absolute-emc.com  
Phone:703-774-7505  
info@absolute-emc.com

## Modulated Wideband Power Amplifier

1dB output compression point @ 5 MHz: 38.4 dBm typ. (Pin: -2 dBm)  
1dB output compression point @ 10 MHz: 38.4 dBm typ. (Pin: -3 dBm)  
1dB output compression point @ 50 MHz: 39.4 dBm typ. (Pin: -1 dBm)  
1dB output compression point @ 75 MHz: 39.4 dBm typ. (Pin: -1 dBm)  
1dB output compression point @ 100 MHz: 39.4 dBm typ. (Pin: -1 dBm)  
1dB output compression point @ 250 MHz: 40.2 dBm typ. (Pin: -1 dBm)  
1dB output compression point @ 500 MHz: 40.1 dBm typ. (Pin: -1 dBm)  
1dB output compression point @ 750 MHz: 38.9 dBm typ. (Pin: -2 dBm)  
1dB output compression point @ 1000 MHz: 38.5 dBm typ. (Pin: -3 dBm)  
1dB output compression point @ 1100 MHz: 38 dBm typ. (Pin: -2 dBm)

2<sup>nd</sup> harmonic, 100 MHz, Pout = 39.4 dBm: < - 21.5 dBc typ.

2<sup>nd</sup> harmonic, 100 MHz, Pout = 34 dBm: < - 15.5 dBc typ.

3<sup>rd</sup> harmonic, 100 MHz, Pout = 39.4 dBm: < - 13 dBc typ.

3<sup>rd</sup> harmonic, 100 MHz, Pout = 34 dBm: < - 23 dBc typ.

Total harmonic distortion:

15.3% @100 MHz, Pout = 31 dBm typ.

18.2% @100 MHz, Pout = 34 dBm typ.

20.1% @100 MHz, Pout = 37 dBm typ.

26.8% @100 MHz, Pout = 39.4 dBm typ.

Third order output intercept point: 44 dBm, @100 MHz,  $\Delta f = 2$  MHz, typ.

Internal modulation frequency AM: 1 kHz  $\pm$  20%

Internal modulation frequencies PM: 1 kHz  $\pm$  20%, 217 Hz  $\pm$  20%

Duty cycle, PM: 50%  $\pm$  10% @ 1 kHz; 12.5%  $\pm$  20% @ 217 Hz

### Maximum ratings:

Maximum input power: +0 dBm

The output of the TBMDA3B is quite tolerant to output mismatch, however open or shorted load is not recommended, as it potentially can cause damage to the output transistor. When driving near field probes, current probes or any load of unknown impedance, it is highly recommended to insert a 3dB attenuator at the output of the amplifier in order to protect the output stage.

Sales Partner:



ABSOLUTE EMC Lic.  
Covering sales in North America  
United States, Mexico, & Canada

absolute-emc.com  
Phone:703-774-7505  
info@absolute-emc.com

# Modulated Wideband Power Amplifier

## Gain flatness:

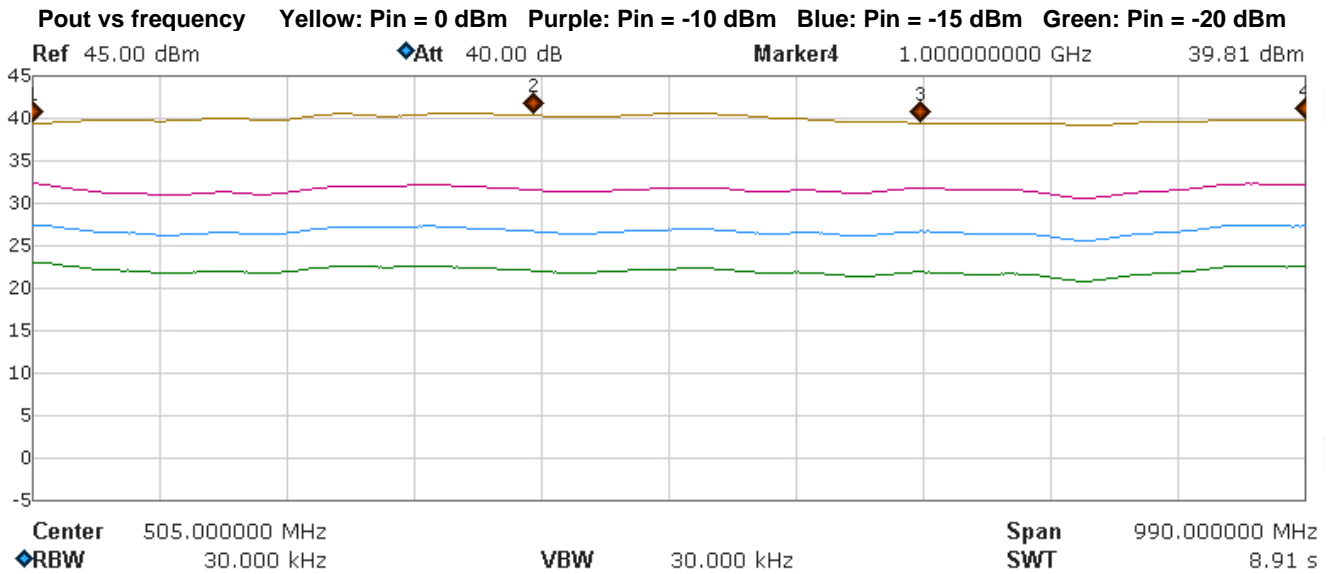

## Marker Table

Marker	Trace	Readout	X Axis	Ampt
Marker1	A	Frequency	10.000000 MHz	39.28 dBm
Marker2	A	Frequency	400.000000 MHz	40.30 dBm
Marker3	A	Frequency	700.000000 MHz	39.41 dBm
Marker4	A	Frequency	1.000000000 GHz	39.81 dBm

## Small Signal Performance (@ Pin = - 15 dBm):

Frequency [MHz]	5	10	25	50	75	100	250	500	600	750	1000	1050	1100
Output power [dBm]	26.02	27.41	27.27	26.83	26.49	26.35	27.17	26.84	26.52	26.4	27.29	27.12	26.29
Gain [dB]	41.02	42.41	42.27	41.83	41.49	41.35	42.17	41.84	41.52	41.4	42.29	42.12	41.29

Table 1 – TBMDA3B small signal gain, typ.

## 1 dB compression point:

Frequency [MHz]	5	10	25	50	75	100	250	500	600	750	1000	1050	1100
Output power [dBm]	38.43	38.43	39.45	39.43	39.44	39.37	40.16	40.14	38.97	38.87	38.54	38.9	37.95
Pin [dBm]	-2	-3	-2	-1	-1	-1	-1	-1	-2	-2	-3	-2	-2

Table 2 – TBMDA3B, 1 dB compression point versus frequency, typ.

## Saturation (@ Pin = 0 dBm):

Frequency [MHz]	5	10	25	50	75	100	250	500	600	750	1000	1050	1100
Output power [dBm]	39.06	39.28	39.45	39.67	39.74	39.71	40.49	40.52	39.99	39.45	39.81	39.47	38.66
Gain [dB]	39.06	39.28	39.45	39.67	39.74	39.71	40.49	40.52	39.99	39.45	39.81	39.47	38.66

Table 3 – TBMDA3B, Saturation versus frequency, typ.

Sales Partner:



ABSOLUTE EMC Lic.  
 Covering sales in North America  
 United States, Mexico, & Canada

absolute-emc.com  
 Phone:703-774-7505  
 info@absolute-emc.com

# Modulated Wideband Power Amplifier

## Modulation:

Zero span, 10 ms sweep time, peak detector

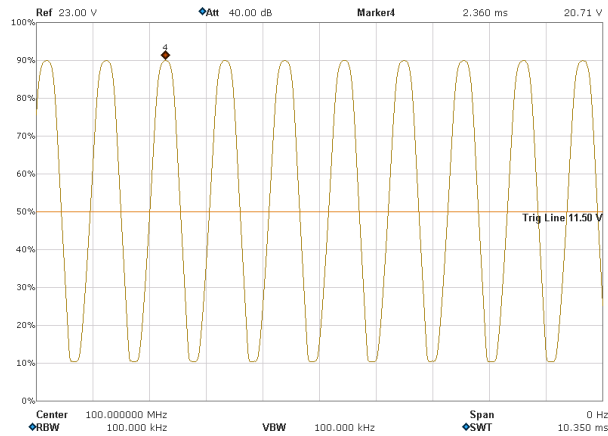

Figure 1 – 1 kHz, 80 % AM, envelope, 100 MHz, Pout = 39.9 dBm peak;

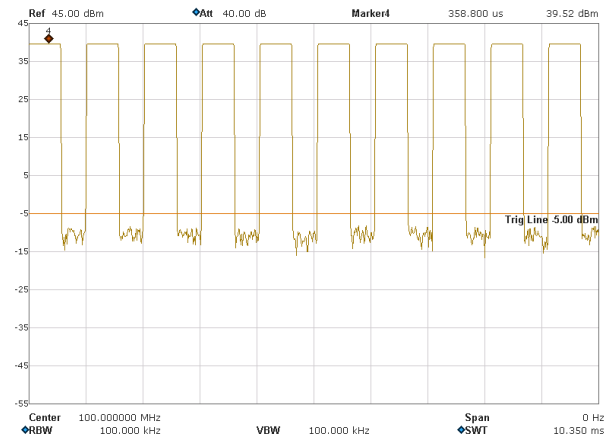

Figure 2 – 1 kHz, 50 % PM envelope, 100 MHz, Pout = 39.9 dBm peak

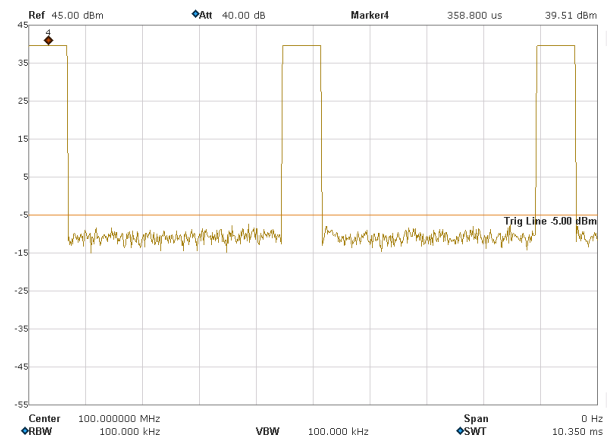

Figure 3 – 217 Hz, 12.5 % PM envelope, 100 MHz, Pout = 39.9 dBm peak

Sales Partner:



**ABSOLUTE EMC** Lic.  
Covering sales in North America  
United States, Mexico, & Canada

absolute-emc.com  
Phone:703-774-7505  
info@absolute-emc.com

## Modulated Wideband Power Amplifier

### 3 Applications - radiated immunity

#### Immunity testing using a TEM cell

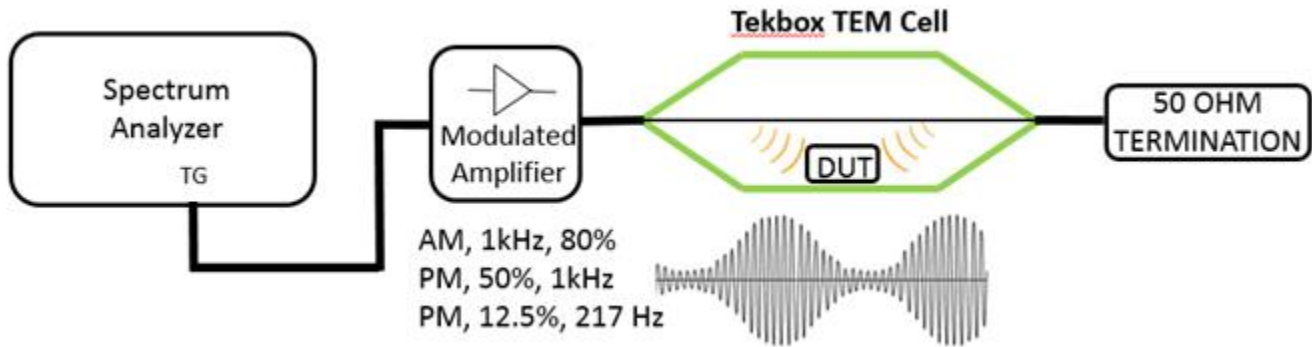

Figure 4 – immunity testing set up

#### Immunity testing using near field probes

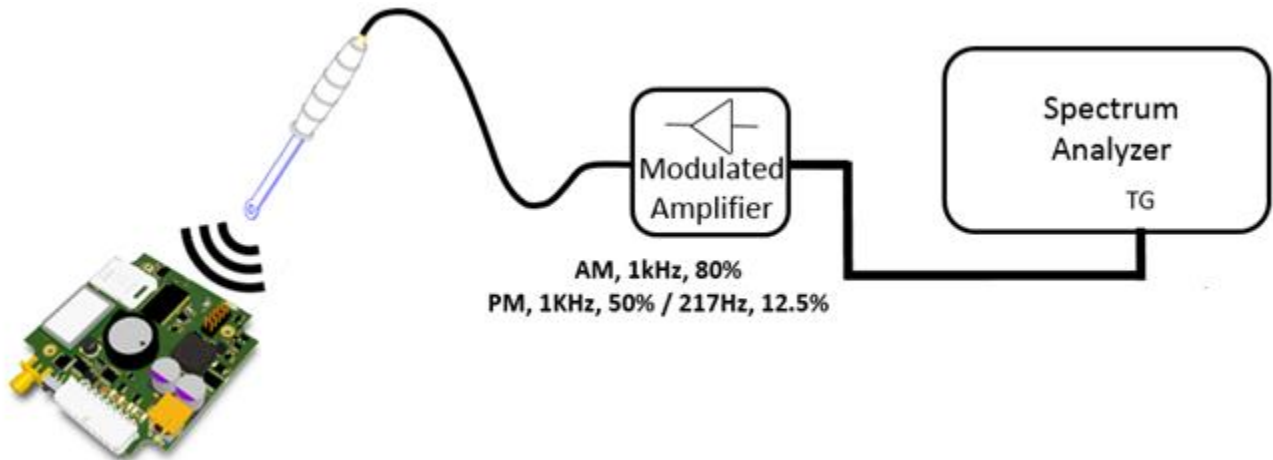

Figure 5 – immunity testing set up to locate susceptible areas on PCBAs

Radiated immunity EMC pre-compliance is typically a 2-step procedure. First, a TEM cell is used to investigate for immunity issues of the DUT. In case of any failure, near-field probes will be used to locate the sensitive circuitry on the PCBA.

Sales Partner:



ABSOLUTE EMC Lic.  
Covering sales in North America  
United States, Mexico, & Canada

absolute-emc.com  
Phone:703-774-7505  
info@absolute-emc.com

## Modulated Wideband Power Amplifier

### TEM Cell field strength

A typical pre-compliance set up for immunity testing is typically not equipped with an E-field probe to measure the real field strength inside the TEM cell. However, the field strength can be calculated with sufficient accuracy for EMC pre-compliance set-ups.

The E-field (V/m) between septum and lower (upper) wall of a TEM cell is  $E = V/d$  where V is the RMS voltage of the applied signal and d is the distance between septum and lower (upper) wall. This is based on the simplified assumption that the E field would be perfectly homogenous/evenly distributed. A more practical formula is  $E = V*Cor/d$  where Cor is a correction factor for the average field strength over the volume of the DUT derived from the analysis of the field distribution over the cross section of the cell.

Assuming the DUT is placed in the center of the cell and in the middle between bottom wall and septum, we can use the simplified formula with sufficient accuracy.

$$TBTC0: d = 2.8 \text{ cm} \rightarrow E_{[V/m]} = (\sqrt{P*50\Omega}) * 35.7$$

$$TBTC1: d = 5 \text{ cm} \rightarrow E_{[V/m]} = (\sqrt{P*50\Omega}) * 20$$

$$TBTC2: d = 10 \text{ cm} \rightarrow E_{[V/m]} = (\sqrt{P*50\Omega}) * 10$$

$$TBTC3: d = 15 \text{ cm} \rightarrow E_{[V/m]} = (\sqrt{P*50\Omega}) * 6.66$$

The power P in the formulas above has to be entered in [Watt]

$$P_{[W]} = 0.001 * (10^{(P_{[dBm]}/10)})$$

Frequency [MHz]	Input power [dBm]	Output power [dBm]	Field strength TBTC0 [V/m]	Field strength TBTC1 [V/m]	Field strength TBTC2 [V/m]	Field strength TBTC3 [V/m]
5	-3	38	634.1	355.2	177.6	118.3
10	-3	38.7	688.1	385.5	192.7	128.4
25	-3	39	712.3	399	199.5	132.9
50	-3	38.9	704.9	394.9	197.5	131.5
75	-3	38.6	678.7	380.2	190.1	126.6
100	-3	38.4	662.5	371.1	185.6	123.6
250	-3	39.2	725.5	406.5	203.2	135.4
500	-3	39.2	724.7	406	203	135.2
600	-3	38.2	651.1	364.8	182.4	121.5
750	-3	38.3	657.1	368.1	184.1	122.6
1000	-3	38.5	674.8	378	189	-
1050	-3	38.4	664.7	372.4	186.2	-
1100	-3	37.4	591.1	331.1	165.6	-

Table 4 – calculated field strength for the TBMDA3B driving Tekbox TEM cells

The above output power is the RMS output power in case of a CW signal. Note that in case of 80% AM modulation, the RMS power of the modulated signal will be 5.1 dB lower than the RMS power of the CW signal.

Sales Partner:



ABSOLUTE EMC Lic.  
Covering sales in North America  
United States, Mexico, & Canada

absolute-emc.com  
Phone: 703-774-7505  
info@absolute-emc.com

## Modulated Wideband Power Amplifier

### 4 Applications - conducted immunity, using CDNs

#### EN 61000-4-6 calibration set up using EMCview PRO

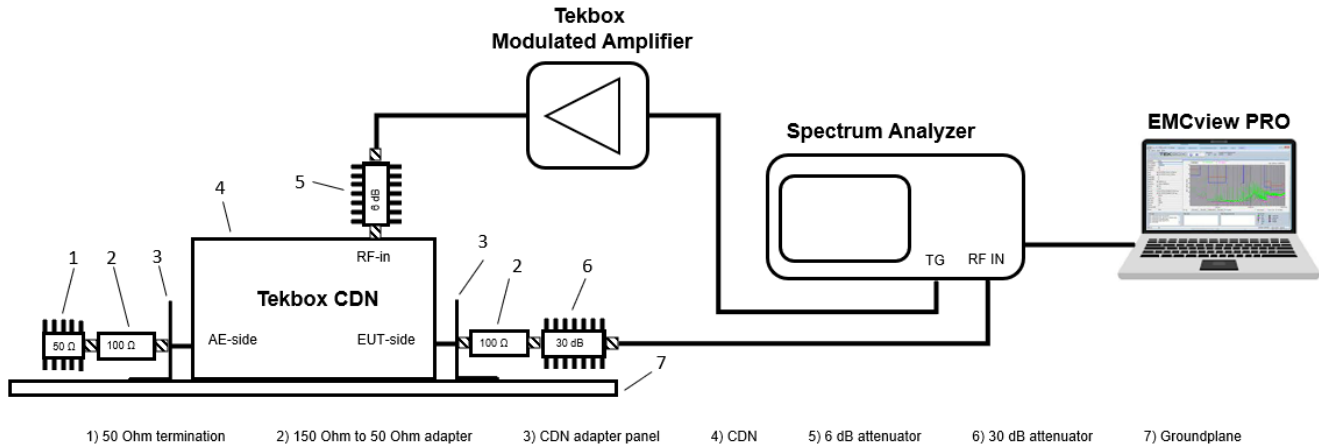

- Test Level 1:        1V RMS, 1 kHz / 80% AM modulated
- Test Level 2:        3V RMS, 1 kHz / 80% AM modulated
- Test Level 3:        10V RMS, 1 kHz / 80% AM modulated
- Test Level X:        special (unspecified)

The specified test levels are open circuit voltages at the EUT port of the CDN.

The voltages measured during calibration must be multiplied by 3 to allow for the 50 Ohm to 150 Ohm conversion and again by 2 to reach the open circuit voltage.

Hence, the measured voltage at the output of the 150 Ohm to 50 Ohm adapter is  $1/6^{\text{th}}$  the voltage of the desired stress level. In logarithmic figures, the measured voltage is 15.5 dB lower than the open circuit voltage.

Example: Test level 2

$U_0 = 3V$  RMS open circuit voltage at the EUT port of the CDN =  $3V/6 = 0.5V$  RMS at the output of the 100 Ohm to 50 Ohm adapter.

The required power at the output of the modulated amplifier is:

$U_0/6$  [dBm] + CDN insertion loss + 6 dB (Attenuator) + 5.1 dB (80% AM RMS)

Assuming 10 dB insertion loss for the CDN, the required RF power is:

$7 \text{ dBm} + 10 \text{ dB} + 6 \text{ dB} + 5.1 \text{ dB} = 28.1 \text{ dBm} = 0.65 \text{ Watt}$

During calibration, EMCview Pro will make a stepped sweep, for each frequency adjusting the tracking generator level in order to achieve  $7 \text{ dBm} + 5.1 \text{ dB} - 30 \text{ dB} = -17.9 \text{ dBm}$  at the spectrum analyzer input. The tracking generator level table will then be used to set levels during the actual immunity test.

Sales Partner:



ABSOLUTE EMC Lic.  
Covering sales in North America  
United States, Mexico, & Canada

absolute-emc.com  
Phone: 703-774-7505  
info@absolute-emc.com



## Modulated Wideband Power Amplifier

The typical insertion loss of a CDN with attached 150 Ohm to 50 Ohm adapter is 10 dB.

Adding the 6 dB attenuator and 5.1 dB for the AM RMS conversion results in a quasi-insertion loss of 10 dB + 6 dB + 5.1 dB = 21.1 dB.

For open circuit voltages of 1V, 3V and 10V, the corresponding power at the output of the 150 Ohm to 50 Ohm adapter is -2.6 dBm, 7 dBm, 17.4 dBm RMS CW. Add 5.1 dB to cover the RMS power of 80% AM modulation.

Consequently, the required power at the input of the 6 dB attenuator for class 1/2/3 is 18.5 dBm / 28.1 dBm / 38.5 dBm.

The table below reflects the insertion loss versus frequency of a real CDN in order to set the required input power for the TBMDA3B.

Frequency [MHz]	TBMDA3B output power to achieve stress level 1 [dBm]	Corresponding TBMDA3B input power [dBm]	TBMDA3B output power to achieve stress level 2 [dBm]	Corresponding TBMDA3B input power [dBm]	TBMDA3B output power to achieve stress level 3 [dBm]	Corresponding TBMDA3B input power [dBm]
5	17.3	-24	27.3	-14	37.3	-4
10	16.6	-26	26.6	-16	36.6	-6
50	16.9	-25	26.9	-15	36.9	-5
100	17.8	-24	27.8	-14	37.8	-4
150	18.7	-23	28.7	-13	38.7	-3
230	20	-22	30	-12	40	-1

Table 4 - measured input power settings for the TBMDA3B in order to achieve stress level 1 and 2

EMCview PRO has the capability to automatically adjust the tracking generator level in order to achieve the desired stress level voltage. The output is a calibration table, which is loaded and applied during the immunity test.

### EN 61000-4-6 immunity test set up using EMCview PRO

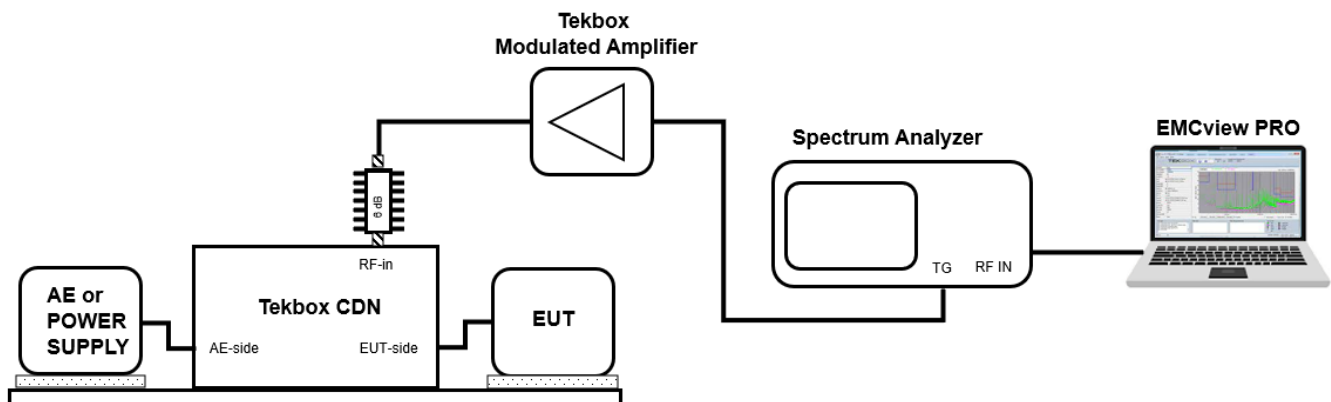

Sales Partner:



ABSOLUTE EMC Lic.  
Covering sales in North America  
United States, Mexico, & Canada

absolute-emc.com  
Phone:703-774-7505  
info@absolute-emc.com

## Modulated Wideband Power Amplifier

### 5 Applications - conducted immunity, using BCI probes

EN 61000-4-6 specifies stress levels in terms of voltage and calibrates the immunity set up using a 300 Ohm loop. Other standards specify stress levels in terms of injected current.

#### EN 61000-4-6 300 Ohm loop BCI calibration set up using EMCview PRO

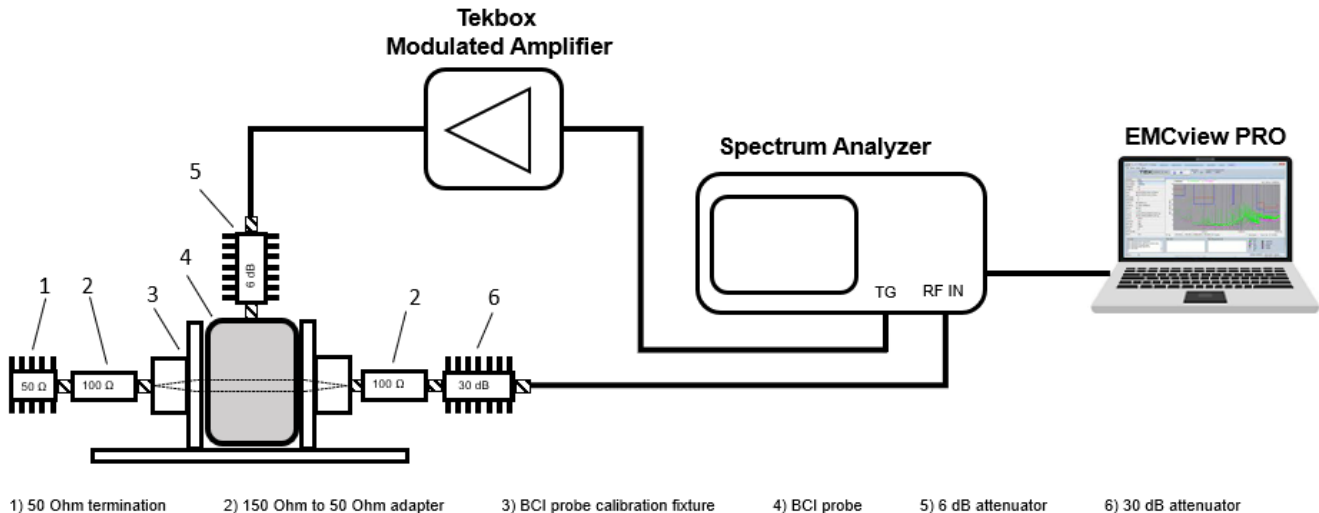

- Test Level 1:        1V RMS, 1 kHz / 80% AM modulated
- Test Level 2:        3V RMS, 1 kHz / 80% AM modulated
- Test Level 3:        10V RMS, 1 kHz / 80% AM modulated
- Test Level X:        special (unspecified)

The specified test levels are open circuit voltages at the output of the calibration fixture.

The voltages measured during calibration must be multiplied by 3 to allow for the 50 Ohm to 150 Ohm conversion and again by 2 to reach the open circuit voltage.

Hence, the measured voltage at the output of the 150 Ohm to 50 Ohm adapter is 1/6<sup>th</sup> the voltage of the desired stress level. In logarithmic figures, the measured voltage is 15.5 dB lower than the open circuit voltage.

Example: Test level 2  $U_0 = 3V$  RMS open circuit voltage at the output of the calibration fixture =  $3V/6 = 0.5V$  RMS at the output of the 100 Ohm to 50 Ohm adapter.

The required power at the output of the modulated amplifier is:

$$U_0/6 \text{ [dBm]} + \text{BCI probe insertion loss} + 6 \text{ dB (Attenuator)} + 5.1 \text{ dB (80\% AM RMS)}$$

Assuming 16 dB insertion loss for the BCI probe in a 300 Ohm loop, the required RF power is:

$$7 \text{ dBm} + 16 \text{ dB} + 6 \text{ dB} + 5.1 \text{ dB} = 34.1 \text{ dBm} = 2.6 \text{ Watt}$$

During calibration, EMCview Pro will make a stepped sweep, for each frequency adjusting the tracking generator level in order to achieve 7 dBm -30 dB = -23 dBm at the spectrum analyzer input. The tracking generator level table will then be used to set levels during the actual immunity test.

Sales Partner:



ABSOLUTE EMC Lic.  
Covering sales in North America  
United States, Mexico, & Canada

absolute-emc.com  
Phone: 703-774-7505  
info@absolute-emc.com

## Modulated Wideband Power Amplifier

### EN 61000-4-6 immunity test set up using a BCI probe and EMCview PRO

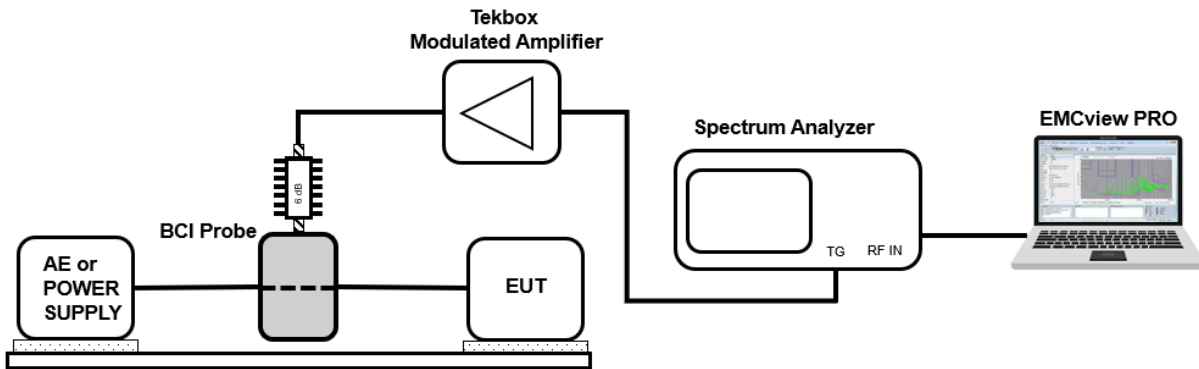

### ISO 11452-4 / MIL-STD-461 / DO 160A calibration set up using EMCview PRO

The automotive immunity standard ISO 11452-4 as well as immunity standards for defense and avionic products specify stress levels in terms of induced disturbance current.

Traditional calibration and test methods use current monitoring probes in order to create a control loop, thereby maintaining the required disturbance current. Levelling loops can be fooled by cable resonances. High impedance resonances cause the RF amplifiers output power to raise, in order to achieve the specified disturbance current. Similarly, low impedance resonances may significantly reduce the RF amplifiers output power. This situation is unrealistic of most real-life electromagnetic environments and could create a severe over-test or under-test situation.

In order to get around the over-test / under-test problems associated with the closed loop test method, the standards offer the substitution method (open loop), where the disturbance current is set by measuring current induced into a 100 Ohm load. Forward and reflected power is measured using a directional coupler while setting the RF power to achieve the required disturbance current levels into the 50 Ohm load. During actual immunity test, the forward power level is set according to the value recorded during calibration.

Substitution calibration method set up for pre-compliance purpose:

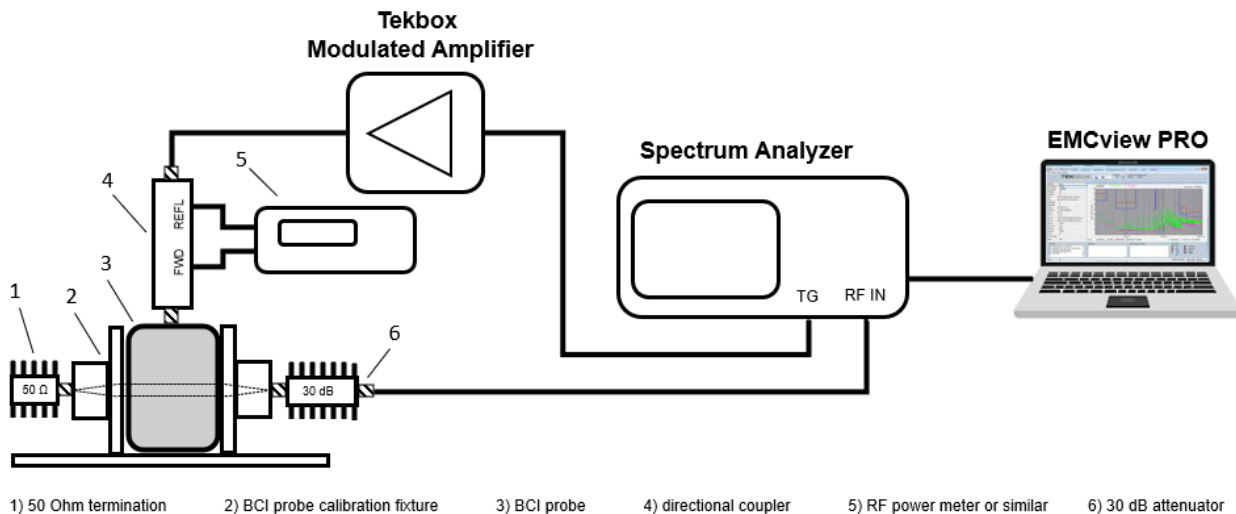

Sales Partner:



ABSOLUTE EMC Lic.  
Covering sales in North America  
United States, Mexico, & Canada

absolute-emc.com  
Phone:703-774-7505  
info@absolute-emc.com

## Modulated Wideband Power Amplifier

Example: Test level I – 60 mA

A power of 22.6 dBm is required to achieve a current of 60 mA in a 50 Ohm load.

Assume 8dB insertion loss for a typical BCI probe in a 100 Ohm loop.

Assume 1 dB insertion loss for the directional coupler

The required power at the output of the modulated amplifier is:

Test level [dBm] + BCI probe insertion loss + 6 dB (Attenuator) + 5.1 dB (80% AM RMS)

22.6 dBm + 8 dB + 1 dB + 5.1 dB = 36,7 dBm = 4.7 W

Example: Test level IV – 200 mA

A power of 33 dBm is required to achieve a current of 200 mA in a 50 Ohm load.

Assume 8dB insertion loss for a typical BCI probe in a 100 Ohm loop.

Assume 1 dB insertion loss for the directional coupler

The required power at the output of the modulated amplifier is:

Test level [dBm] + BCI probe insertion loss + 6 dB (Attenuator) + 5.1 dB (80% AM RMS)

33 dBm + 8 dB + 1 dB + 5.1 dB = 47.1 dBm = 51.3 W

### ISO 11452-4 / MIL-STD-461 / DO 160A immunity test set up using EMCview PRO

Refer to the standards for detailed drawings of the corresponding test set ups.

## 6 PC Software for immunity testing

Tekbox provides two software versions for EMC pre-compliance measurements

EMCview provides a feature to control the tracking generator output frequency and level and carry out sweeps with constant tracking generator level.

EMCview PRO provides a more sophisticated feature, which is able to carry out calibration sweeps for CDN and BCI based set ups. The resulting calibration file is used to set the tracking generator level during the immunity test sweep.

Tekbox EMCview currently supports Rigol, Siglent, Owon, R&S FPC and FPH series spectrum analyzers.

Sales Partner:



ABSOLUTE EMC Lic.  
Covering sales in North America  
United States, Mexico, & Canada

absolute-emc.com  
Phone:703-774-7505  
info@absolute-emc.com

## Modulated Wideband Power Amplifier

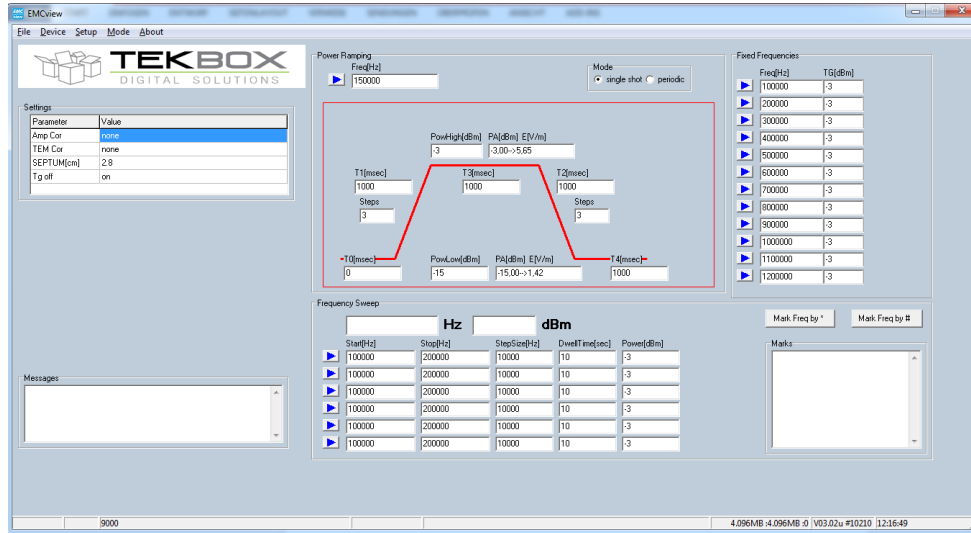

Figure 11 – screenshot of the tracking generator control feature of EMCview / EMCview Pro

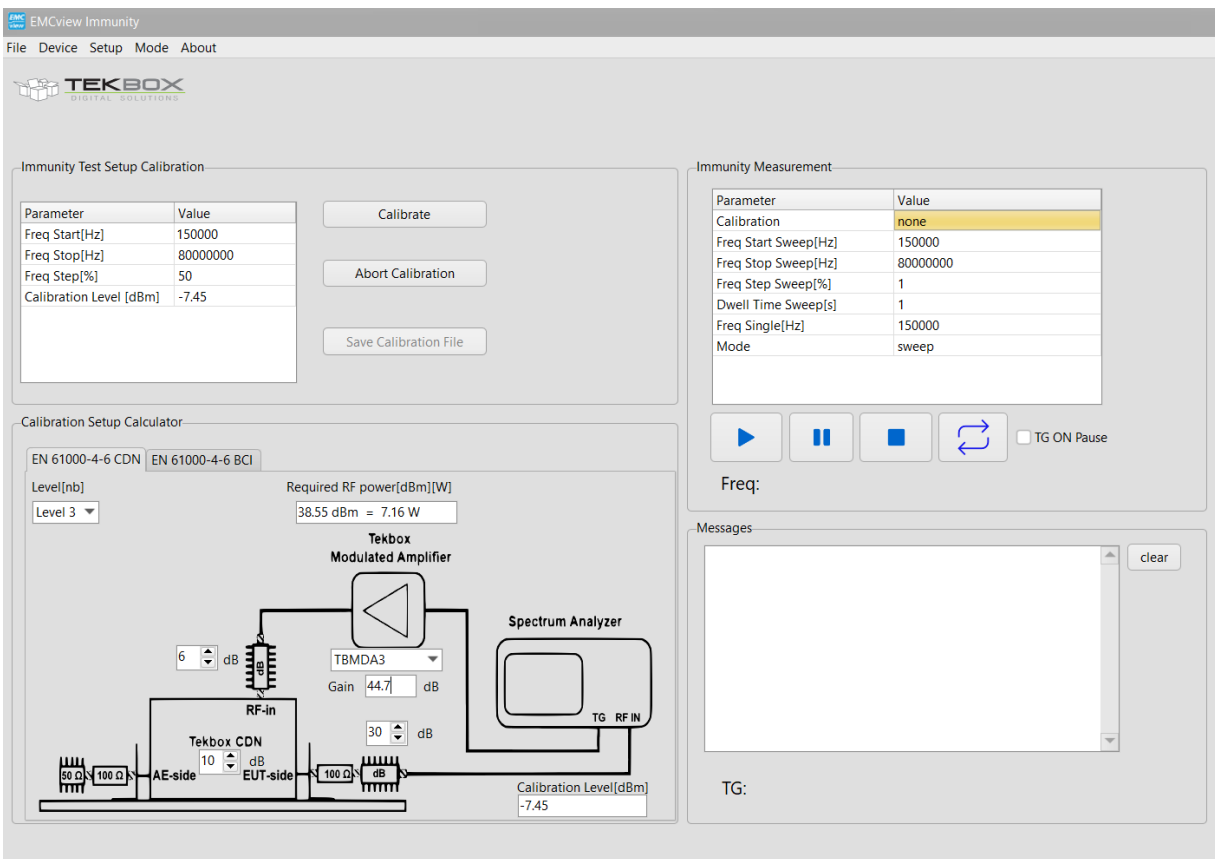

Figure 12 – screenshot of the immunity test feature of EMCview Pro

Sales Partner:



ABSOLUTE EMC Lic.  
Covering sales in North America  
United States, Mexico, & Canada

absolute-emc.com  
Phone: 703-774-7505  
info@absolute-emc.com

## Modulated Wideband Power Amplifier

### WARNING:

**Never connect the output of the TBMDA3B directly to the input of a spectrum analyzer. Check the maximum input ratings of the spectrum analyzer and protect it with an appropriate attenuator. Open or shorted load is not recommended, potentially can cause damage of the RF output stage.**

### Example:

**Rigol DSA815 – maximum input power rating: +20dBm**

## 7 Ordering Information

Part Number	Description
TBMDA3B-EU	modulated power amplifier, 2 pcs 75cm N-male to N-male cables, 1 pc 6 dB attenuator, 1 pc 30dB / 10W attenuator with N-connectors, C13 Schuko power cord
TBMDA3B-US	modulated power amplifier, 2 pcs 75cm N-male to N-male cables, 1 pc 6 dB attenuator, 1 pc 30dB / 10W attenuator with N-connectors, C13 US power cord
TBMDA3B-UK	modulated power amplifier, 2 pcs 75cm N-male to N-male cables, 1 pc 6 dB attenuator, 1 pc 30dB / 10W attenuator with N-connectors, C13 English power cord
TBMDA3B-AU	modulated power amplifier, 2 pcs 75cm N-male to N-male cables, 1 pc 6 dB attenuator, 1 pc 30dB / 10W attenuator with N-connectors, C13 Australian power cord

Table 5 – Ordering Information

## 8 History

Version	Date	Author	Changes
V1.0	9.2.2023	Mayerhofer	Creation of the document
V1.1	17.2.2023	Mayerhofer	Updated chapter 6
V1.2	27.2.2023	Minh Nguyen	Updated Picture 1
V1.3	27.3.2023	Thinh Nguyen	Updated performance

Table 6 – History

www.tekbox.com

**TekBox Digital Solutions Vietnam Pte. Ltd.**

Factory 4, F5, Lot I-3B-1, Saigon Hi-Tech Park, Tan Phu Ward, District 9, Ho Chi Minh City, Vietnam

Sales Partner:



**ABSOLUTE EMC** Lic.  
Covering sales in North America  
United States, Mexico, & Canada

absolute-emc.com  
Phone:703-774-7505  
info@absolute-emc.com