



## 100-TS Series

Sales Partner:



**ABSOLUTE EMC** LLC.  
Covering sales in North America  
United States, Mexico, & Canada

absolute-emc.com  
Phone: 703-774-7505  
info@absolute-emc.com

Arbitrary 4-Quadrant  
Voltage and Current Amplifiers

400 W - 18.000 W  
DC ... 200 kHz / 1 MHz

# Arbitrary 4-Quadrant Voltage and Current Amplifiers 100-TS Series 400 W - 18.000 W DC - 200 kHz / 1 MHz

## Special Features

- DC ... 200 kHz full range bandwidth
- DC up to 1 MHz (small signal -3 dB)
- Output voltage 35 V / 70 V / 75 V
- Rise time / fall time up to 100 V/μs
- Arbitrary function with 1 Million memory data points
- Internal resistor 0 ... 200 mΩ (Option)
- Analogue input 0 ... ±10 V for voltage control
- Option for running as current amplifier
- Monitor outputs for measured values of voltage and current
- WaveMaster software for graphical waveform generation
- Simulation of imported oscilloscope signals
- Modularly expandable up to 18 kW (Systems > 1 kW)
- USB interface standard
- Voltage resolution less than 0.001 V
- Linearity 0,1% DC
- DC - Offset < 1 mV
- DLL's for C++, LabView™, Vector-CAPL, Python, C#, MathLab, etc.

## Model 35N-TS Overview

### +35 V / -16 V

Models	Low voltage -16 V...+16 V	Medium voltage -16 V...+27 V	High voltage -16 V...+35 V	Output Power	Size
105-35N-TS	15 A	15 A	11 A	400 W	3 U
110-35N-TS	38 A	38 A	28 A	1.000 W	4 U
120-35N-TS	76 A	76 A	55 A	2.000 W	14 U
130-35N-TS	114 A	114 A	83 A	3.000 W	18 U
140-35N-TS	152 A	152 A	110 A	4.000 W	22 U
150-35N-TS	190 A	190 A	138 A	5.000 W	26 U
160-35N-TS	228 A	228 A	165 A	6.000 W	30 U
180-35N-TS	304 A	304 A	220 A	8.000 W	2 x 22 U
200-35N-TS	380 A	380 A	276 A	10.000 W	2 x 26 U
220-35N-TS	456 A	456 A	331 A	12.000 W	2 x 30 U
250-35N-TS	570 A	570 A	413 A	15.000 W	3 x 26 U
280-35N-TS	684 A	684 A	496 A	18.000 W	3 x 30 U

Example: Model 110-35N-TS

## Low Voltage Range

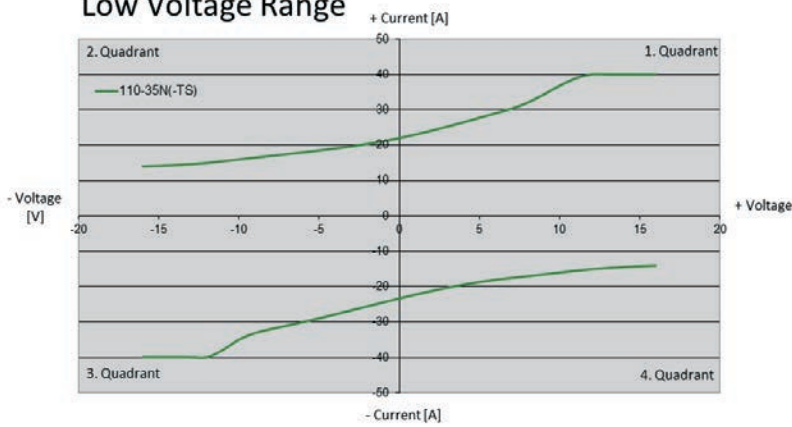

## Middle Voltage Range

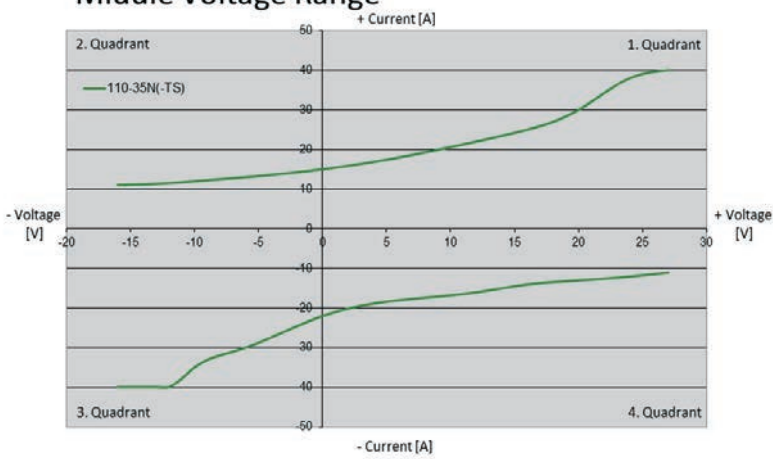

## High Voltage Range

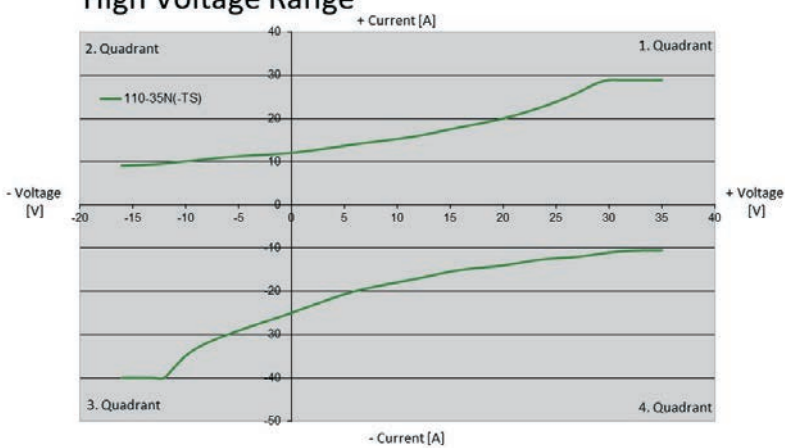



Model 110-70N-TS

# Arbitrary 4-Quadrant Voltage / Current Amplifiers 100-TS Series 500 W - 18.000 W DC - 200 kHz / 1 MHz

## Model 110-70N-TS Overview

### +70 V / -16 V

Models	Low voltage -16 V...+16 V	Medium voltage -16 V...+27 V	High voltage -16 V...+70 V	Output Power	Size
105-70N-TS	19 A	19 A	7 A	500 W	3 U
110-70N-TS	38 A	38 A	14 A	1.000 W	4 U
120-70N-TS	76 A	76 A	29 A	2.000 W	14 U
130-70N-TS	114 A	114 A	43 A	3.000 W	18 U
140-70N-TS	152 A	152 A	57 A	4.000 W	22 U
150-70N-TS	190 A	190 A	71 A	5.000 W	26 U
160-70N-TS	228 A	228 A	86 A	6.000 W	30 U
180-70N-TS	304 A	304 A	114 A	8.000 W	2 x 22 U
200-70N-TS	380 A	380 A	143 A	10.000 W	2 x 26 U
220-70N-TS	456 A	456 A	171 A	12.000 W	2 x 30 U
250-70N-TS	570 A	570 A	214 A	15.000 W	3 x 26 U
280-70N-TS	684 A	684 A	257 A	18.000 W	3 x 30 U

- ✓ **Extremely Powerful**
- ✓ **Modular Design**
- ✓ **Unlimited Signal Waveforms**

Example: Model 110-70N-TS

### Low Voltage Range

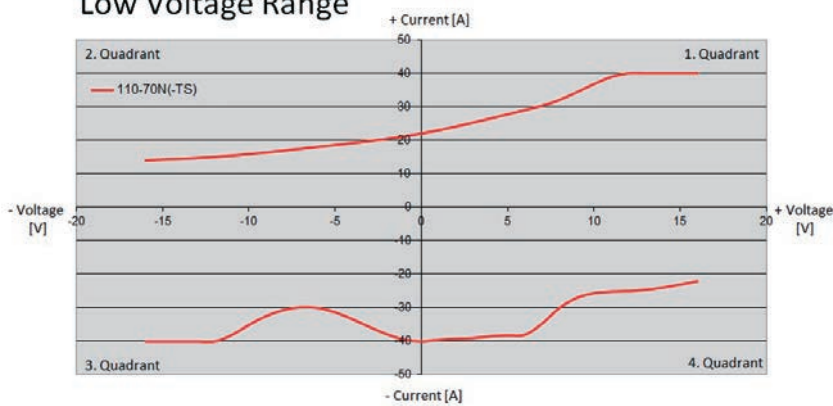

### Middle Voltage Range

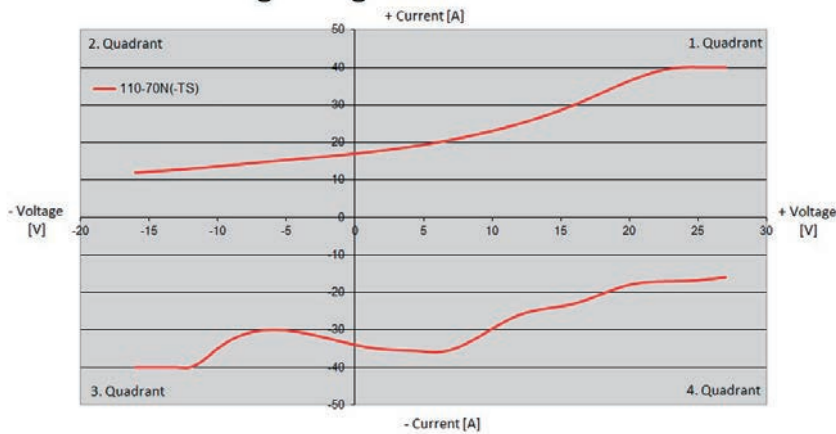

### High Voltage Range

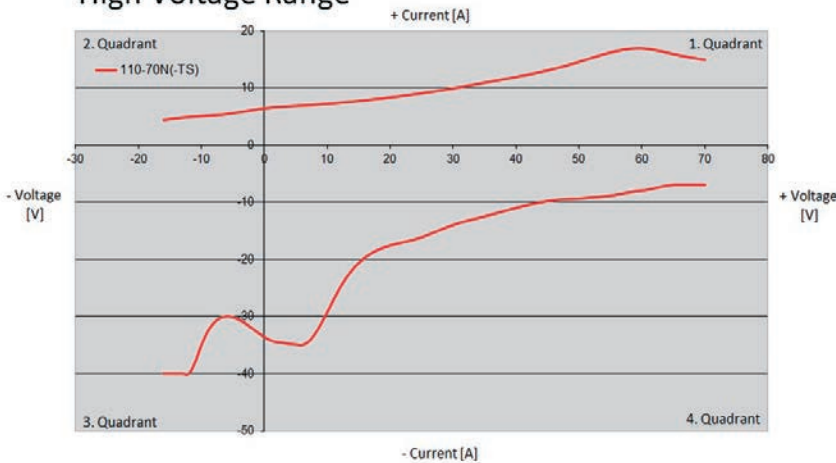

4 kW Test System





Model 105-75N-TS Rear

# Arbitrary 4-Quadrant Voltage and Current Amplifiers 100-TS Series

**500 W - 18.000 W**

**DC - 200 kHz / 1 MHz**

## Model 75N-TS Overview

### +75 V / -75 V

Models	Low voltage -25 V...+25 V	Medium voltage -50 V...+50 V	High voltage -75 V...+75 V	Output Power	Size
105-75N-TS	19 A	10 A	7 A	500 W	3 U
110-75N-TS	38 A	19 A	14 A	1.000 W	4 U
120-75N-TS	76 A	38 A	27 A	2.000 W	14 U
130-75N-TS	114 A	57 A	40 A	3.000 W	18 U
140-75N-TS	152 A	76 A	53 A	4.000 W	22 U
150-75N-TS	190 A	95 A	67 A	5.000 W	26 U
160-75N-TS	228 A	114 A	80 A	6.000 W	30 U
180-75N-TS	304 A	152 A	106 A	8.000 W	2 x 22 U
200-75N-TS	380 A	190 A	133 A	10.000 W	2 x 26 U
220-75N-TS	456 A	228 A	160 A	12.000 W	2 x 30 U
250-75N-TS	570 A	285 A	200 A	15.000 W	3 x 26 U
280-75N-TS	684 A	342 A	239 A	18.000 W	3 x 30 U

Example: Model 110-75N-TS

## Low Voltage Range

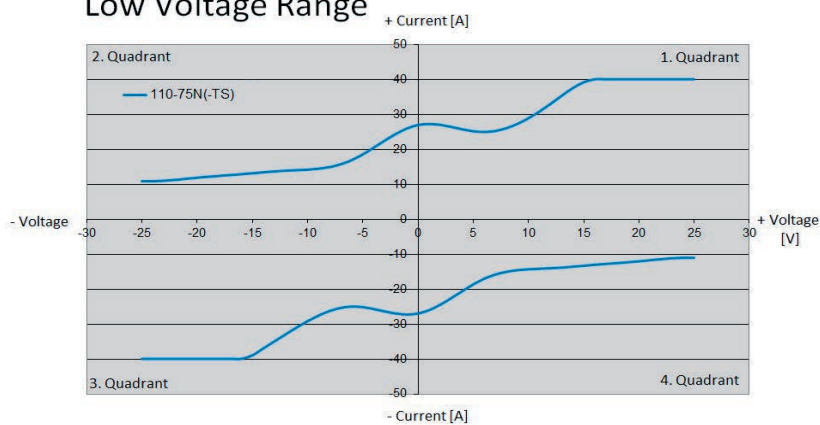

## Middle Voltage Range

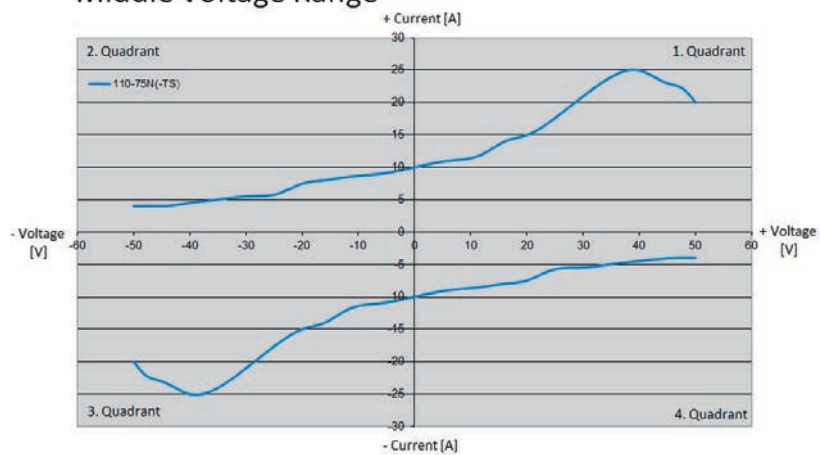

## High Voltage Range

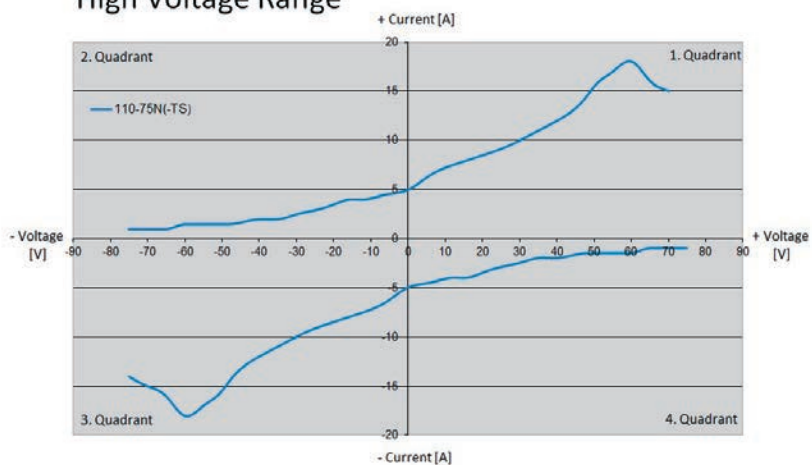

### Selectable Operating Voltage

Three selectable operating-voltage ranges allow to adapt to applications for high voltage / low current or low voltage / high current.

Especially when controlling extremely low impedance loads, the operating voltage range can be reduced to one third of the maximum output voltage. This leads to an immense reduction of power dissipation.

- Reduction of power dissipation
- One system for 12 V / 24 V / 48 V vehicles

# Comparison

110-70N (-16 V...+70 V, 40 A, 1000 W)

with

110-75N (-75 V...+75 V, 40 A, 1000 W)

- 110-70N-TS, -16 V...+16 V
- 110-75N-TS, -25 V...+25 V

## Low Voltage Range

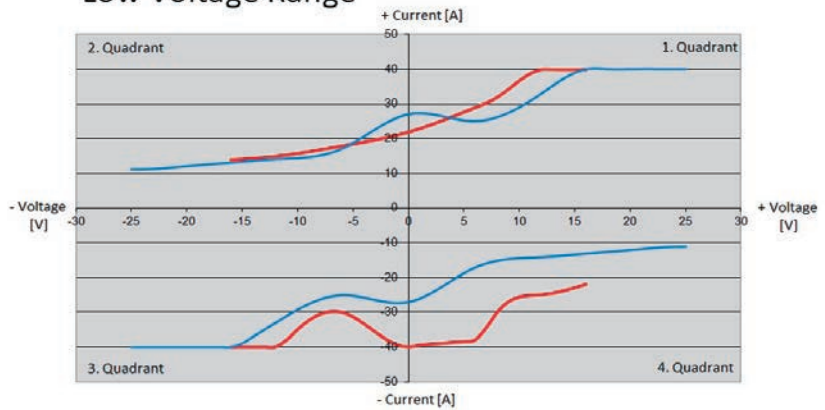

- 110-70N-TS, -16 V...+27 V
- 110-75N-TS, -50 V...+50 V

## Middle Voltage Range

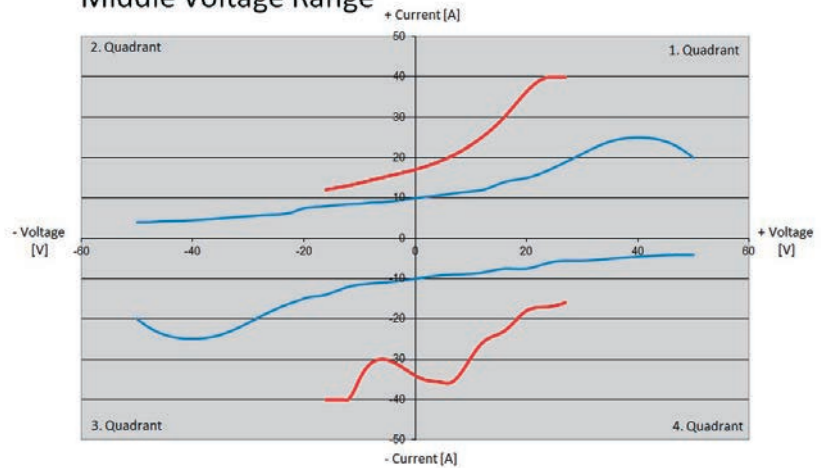

- 110-70N-TS, -16 V...+70 V
- 110-75N-TS, -75 V...+75 V

## High Voltage Range

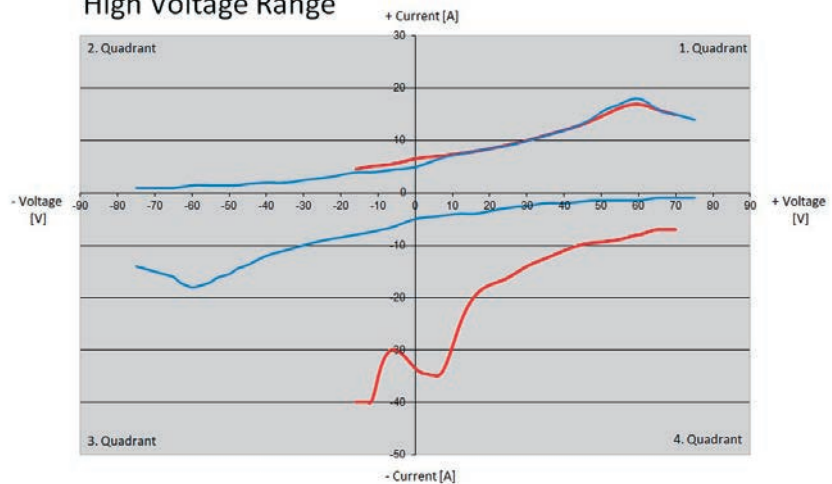



## Comparison

160-70N (-16 V...+70 V, 228 A, 6000 W)

with

160-75N (-75 V...+75 V, 228 A, 6000 W)

### Low Voltage Range

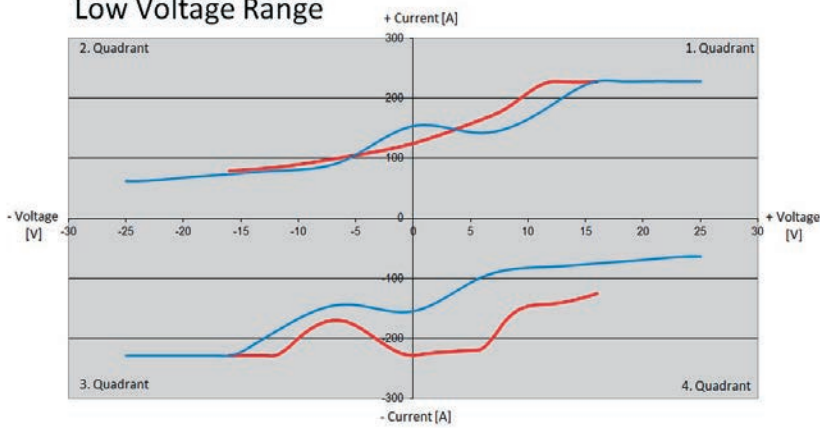

— 160-70N-TS, -16 V...+16 V  
— 160-75N-TS, -25 V...+25 V

### Middle Voltage Range

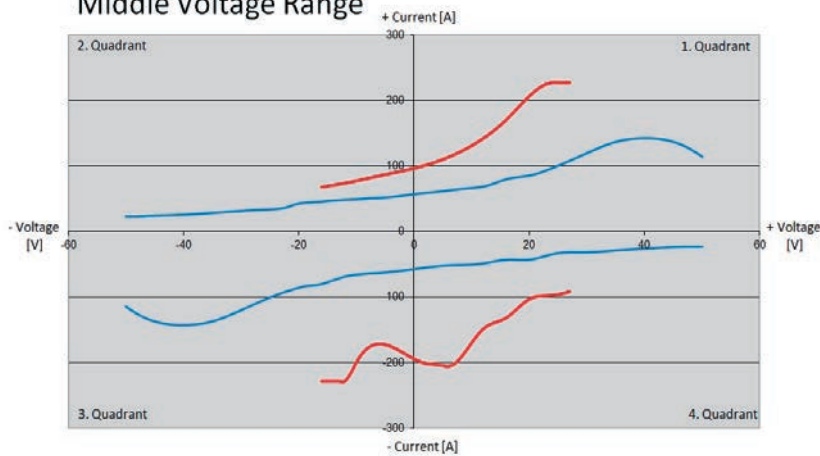

— 160-70N-TS, -16 V...+27 V  
— 160-75N-TS, -50 V...+50 V

### High Voltage Range

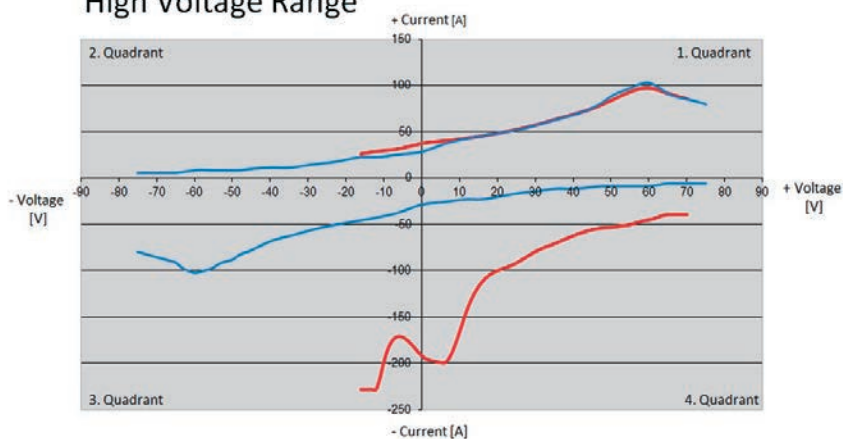

— 160-70N-TS, -16 V...+70 V  
— 160-75N-TS, -75 V...+75 V

# Test System Architecture

## General

The 100-TS series are linear precision 4-quadrant power amplifiers for fast voltage and current signals - each positive and negative (bipolar).

They also work as sink in applications to absorb power. Extremely high bandwidth at highest power requirements, necessary for fast signals, characterizes this series.

Especially these amplifiers are characterized by their signal quality.

## Arbitrary Functionality

BOLAB's arbitrary power amplifiers include a huge memory of 1 Million data points to store arbitrary waveforms in the instrument itself. No arbitrary waveform generator or any other controlling instrument is needed which makes these 4-quadrant amplifiers unique in the world market.

The easy-to-use WaveMaster software, that is standard in scope of delivery, allows to generate waveforms with a graphical user interface or via tabular input.

## Multiple Instrument Functions In One Device

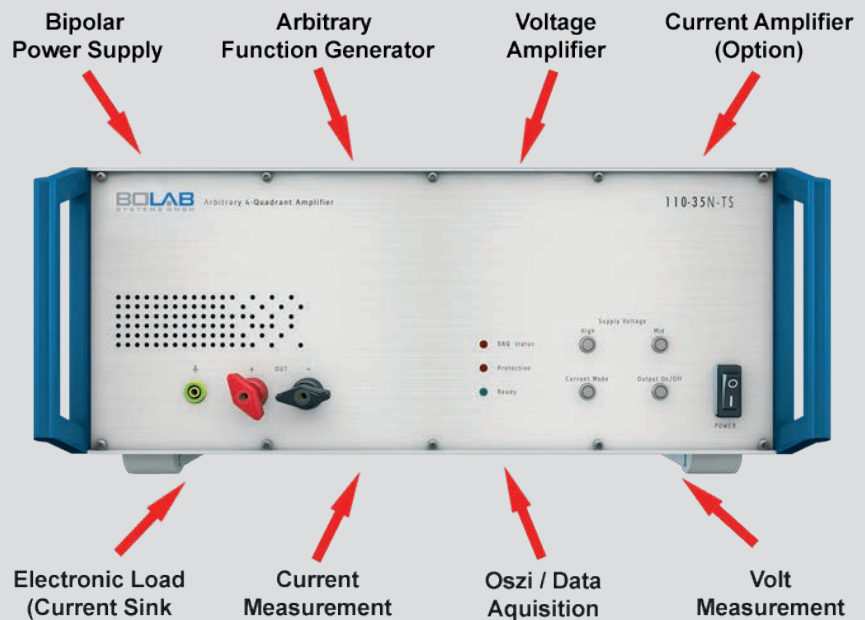

## Monitor Outputs

Located on the back of the instruments there are monitor outputs for voltage and current with the respective measured values.

Output values are  $0 \dots \pm 10 \text{ V}$  for  $0 \dots \pm V_{\text{rated}}$  respectively  $0 \dots \pm I_{\text{rated}}$ .

The current is measured with an internal shunt and accuracy of approx. 1 %.

Optionally a current sensor with 0.01 % accuracy can be integrated easily.

## Output ON/OFF

With its output on/off switch at the front of the instruments, the output can be activated or deactivated. When deactivating, there is a complete galvanic separation to the devices under test.

## Signal Quality

- Rise time:  $< 1 \mu\text{s}$
- Fall time:  $< 1 \mu\text{s}$
- No overshoot / no undershoot

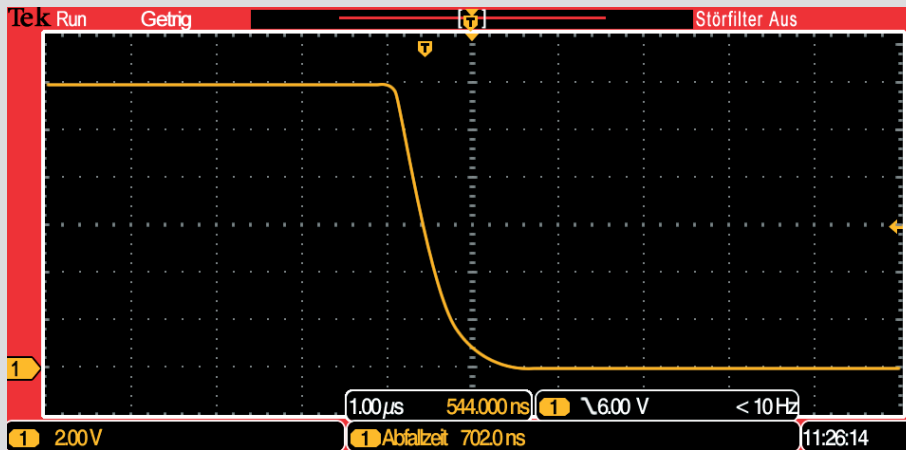

## Protective Functions

Various protective functions avoid damage of the instrument and guarantee protection for the devices under test.

Output voltage and current can be limited. Over-temperature shutdown is included.

The unit's internal calculation of power dissipation and complete monitoring of current ensure perfect short circuit and over-voltage protection.

Also, for security reasons an interlock shut down can be triggered.

## Short-Time Current

Within 500 ms, the amplifier systems supply a short-time current.

E.g. the 1.000 W, 40A will reach 100 A in 500 ms.

Generally the instruments provide a short-time current of approximately two times higher than  $I_{DC\ Max}$

## Short Time Current At Model 110-75N-TS

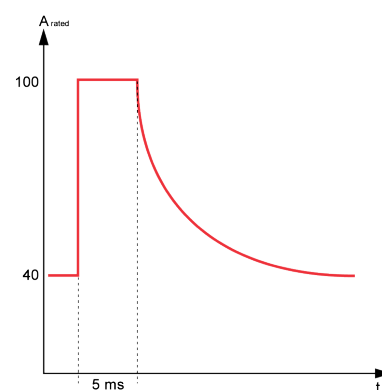

# Test System Architecture

## Two synchronous waveform signals

### Analog Amplifier / Signal Processing

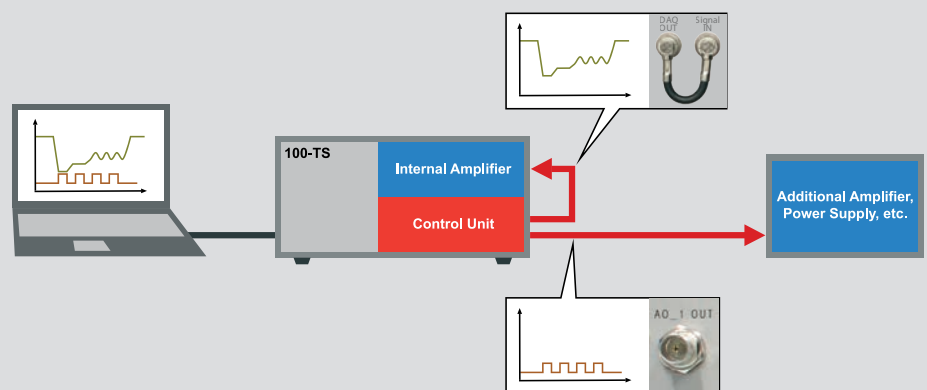

2 Analog Outputs (16 bit), 2,8 MS/s  
(optional 4 / 8 via external control unit)

- First output for control of the internal amplifier
- Second output for control of external hardware (amplifier / power supply)

4 Counter Inputs/ Outputs

- Electronic switch S5
- Electronic switch S5 negated

16 Analog Inputs

- Monitor U (internally wired) (New HMI)
- Monitor I (internally wired) (New HMI)
- Remaining inputs for measurements at user defined measuring points (New HMI)

24 Digital Inputs/ Outputs

- Run-Bit
- External Trigger
- Internal Trigger

## Unlimited Waveform Memory

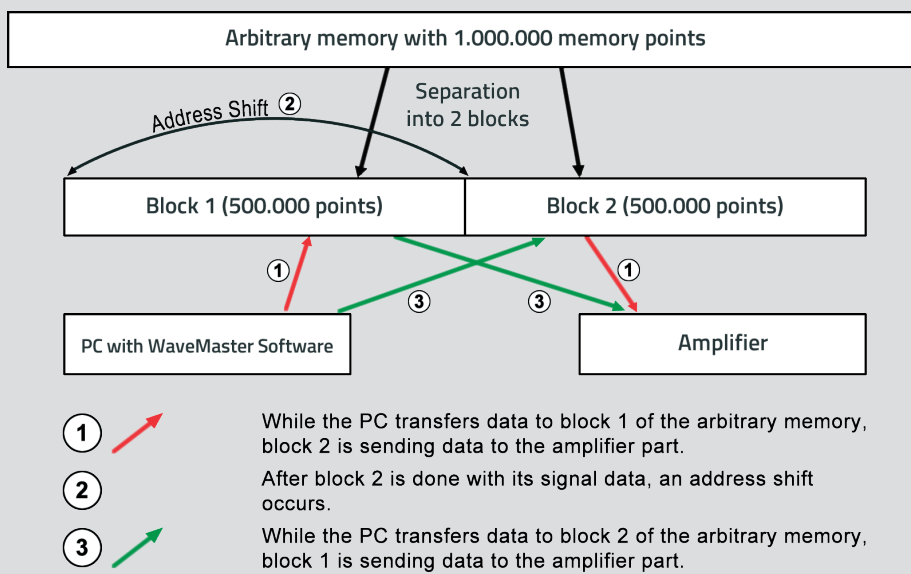

⇒ This technology enables an endless, continuous data stream to the amplifier.

- ⇒ Compared to a function generator with its limited arbitrary memory there is no limitation of the size of the waveform.
- ⇒ A waveform with small spikes and interruptions of e.g. 100  $\mu$ s and long constant levels in between can be simulated easily.

# Analog Remote Control

## Amplifier Control

There are many ways to control BOLAB amplifier systems:

- **BOLAB WaveMaster Software**  
This PC software generates waveforms, sends the curves to the internal data memory and runs the process. All selections in the instrument are done automatically.
- **Function Generator**  
Standard function generators can be connected directly to the input of the amplifier.
- **NI DAQ Card, VT System (Vector), etc.**  
Through their  $0..±10\text{ V}$  input, other control units can be used for waveform generation. Automated test systems don't need programming adaptations.

## Multiple Control Possibilities

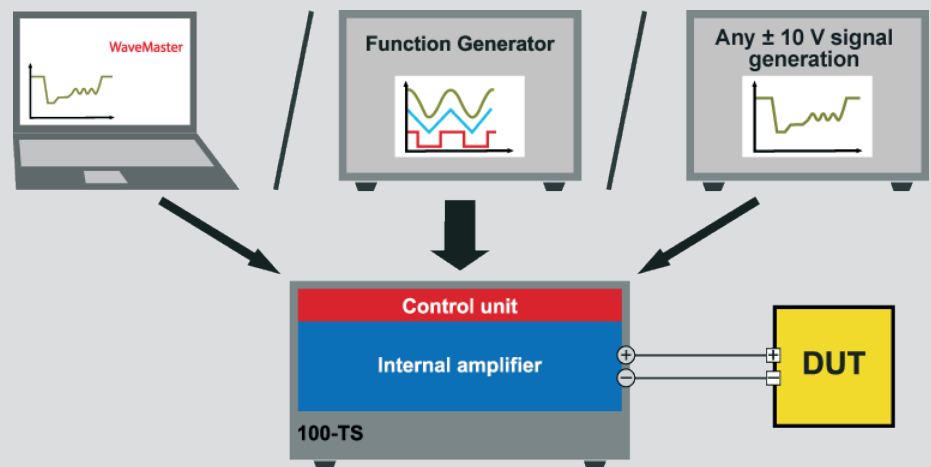

# Adding two independent signals to one waveform

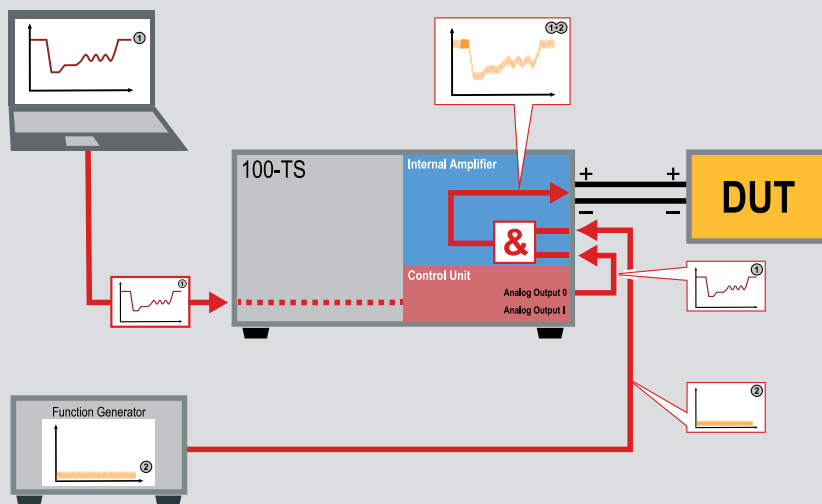
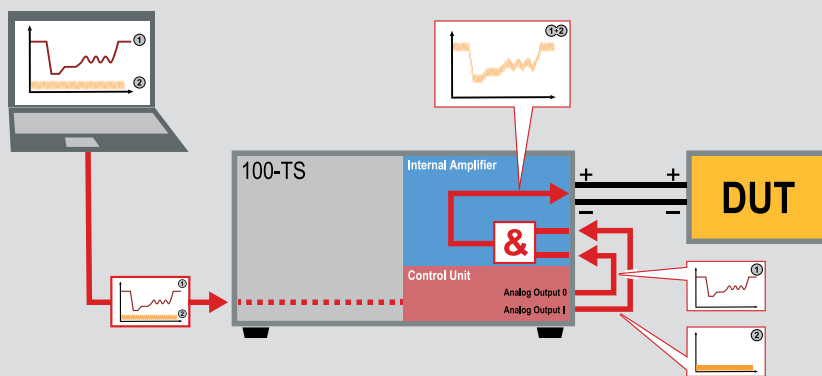

## Amplifier Control

With an optional isolation amplifier, the instruments have two analog inputs. These inputs are added in the isolation amplifier. This allows to add e.g. an interference on a standard waveform.

The second waveform may either come from the PC or from an external Function Generator.

# Modular Design

## Voltage And Current Control

Both voltage and current control of the comprehensive amplifiers is possible. This can be selected on the front panel of the instrument.

Control input is  $0 \dots \pm 10 \text{ V}$   
for  $0 \dots \pm V_{\text{Rated}}$  respectively  $0 \dots \pm I_{\text{Rated}}$ .

An optional compensation network for current control is necessary, which achieves highest slew rates and signal quality for current signals.

## Modular Concept / Modularly Expandable

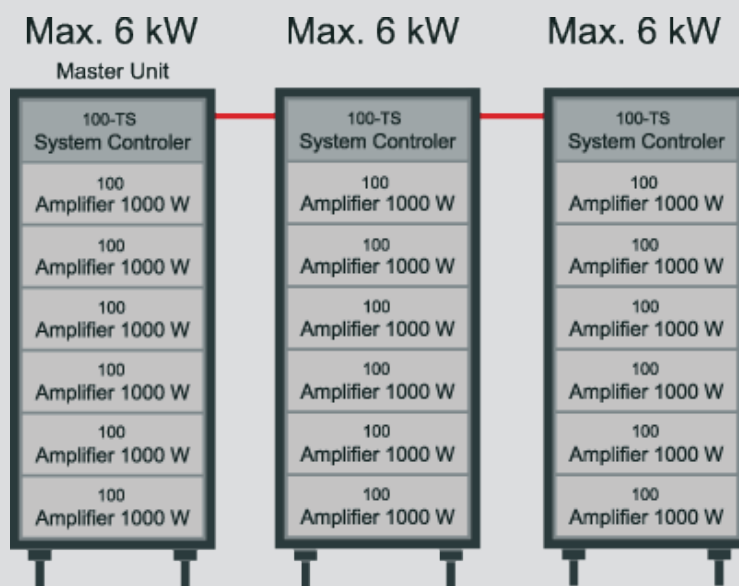

- Modular hardware architecture
- Starting with one single unit of e.g. 1 kW
- Extension up to 18 kW in parallel
- Building up 3-phase systems with up to 6 kW per phase
- Serial connection for increasing voltage
- In case of a defective module, only this module needs to be repaired
- Each module has its own indication for functional capability



# Cascading

## Synchronous DUT Control

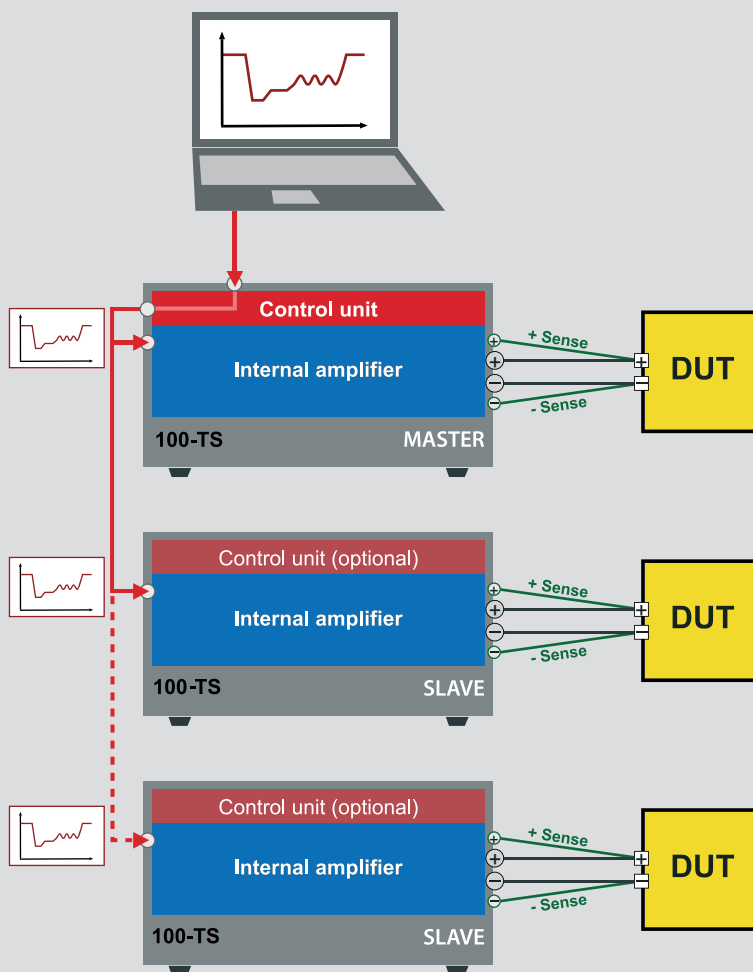

## One Waveform, Many Amplifiers

- One waveform can be simulated synchronously with several amplifiers
- Each DUT has its own sense

# Series Operation

## Series Operation

For high-voltage applications, two instruments or more can be connected.

- Two instruments can be connected in series. Bridge switch must be toggled at one amplifier
- For three and more instruments in series, an internal isolation amplifier in each instrument is necessary

## Two Instruments In Series

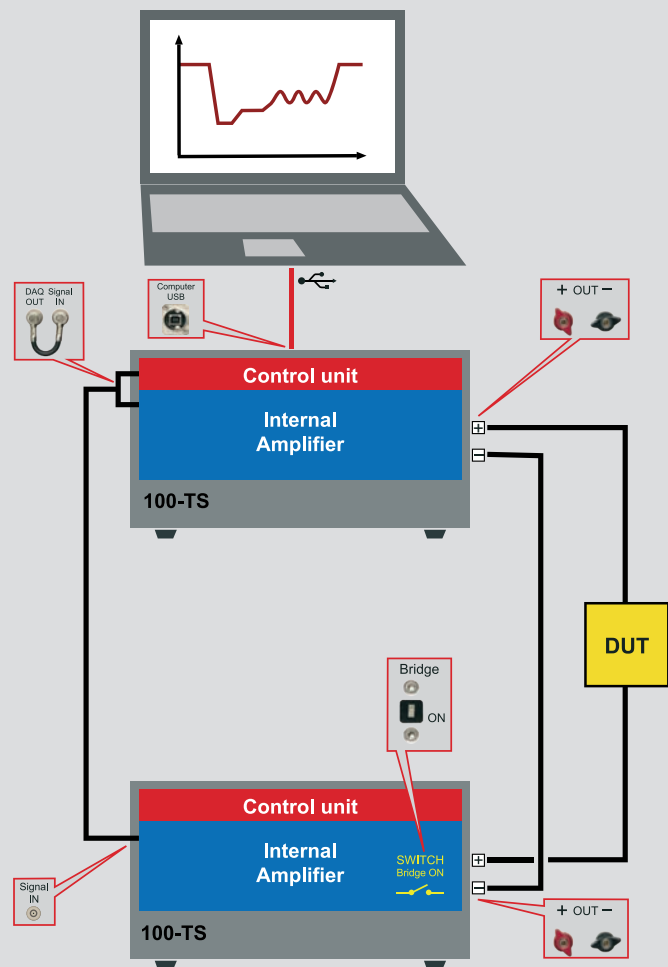



# WaveMaster Software

## Waveform generation and 4-quadrant amplifier control

### Special Features

- Easy to use graphical waveform editor and tabular input possibility
- Command library for integration into automated test systems:
  - LabView(TM)
  - Vector CANoe (CAPL)
  - C#
  - C++
  - ANSI C
  - Python
  - etc.
- Simulation of imported oscilloscope signals
- Waveform trigger caused by external TTL signal (rising edge) for synchronization
- Macro function for execution of automated tests

### Waveform Generation

The powerful and easy to use WaveMaster software is unique in world market. Without any knowledge in software development, construction of ordinary and complex waveforms is dead easy.

A graphical waveform editor allows to generate individual curves in a flash. Also with a tabular input all kinds of waveforms can be produced immediately.

The simplicity how fast to import data out of oscilloscopes is amazing. Read in ASCII data files is possible in the same way.

### Digital Interface USB

All functionalities of the 4-quadrant amplifiers are available in WaveMaster software for controlling the instruments.

Short time current on/off, output on/off, operating voltage range and other functions can be easily set with its USB interface.

### Trigger Function

A hardware trigger input can be activate to monitor a TTL input signal on its rising edge. Synchronous waveform simulation, measurement and testing tasks are predestined applications.

### Macro Function

With a comfortable macro editor and its execution, selected waveforms run sequentially. Bursts, repetitions and loops make testing easy without any software coding.

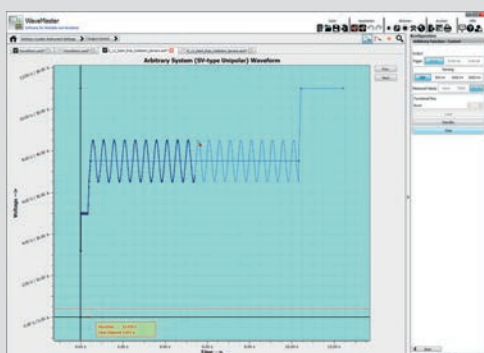

Red cursor shows the current position while waveform is running

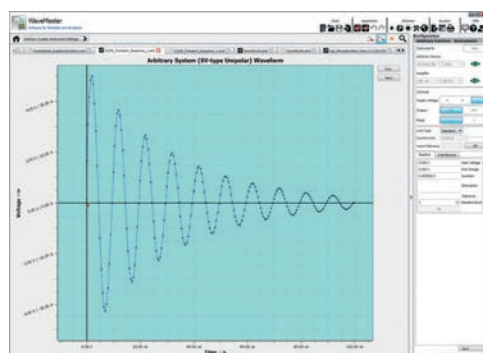

Example out of JLR-EMC-CS CI 250

## WaveMaster Remote DLL

With the WaveMaster remote DLL's, available for nearly all programming languages, with its command library, users control the 4-quadrant amplifiers in an absolute perfection. There is no need to handle hardware interfaces such as USB or LAN.

One command for each function handles all interfaces. Data files are sent to the instrument within milliseconds. No need to concern about memory space and resolution of the amplifiers.

A simple "load" command calculates the best resolution of the waveform that is possible and sends data to the arbitrary unit. In every DLL (LabView™, Vector CANoe, C#, C++, ANSI C, Python, etc.), commands are identical. This makes switching between programming languages convenient. Commands for creating waveforms out of user programming surroundings are included as well. Variable waveforms for simulation of increasing ramps in time, variation of frequency and many other applications are typical test scenarios.



Starting monitor of WaveMaster

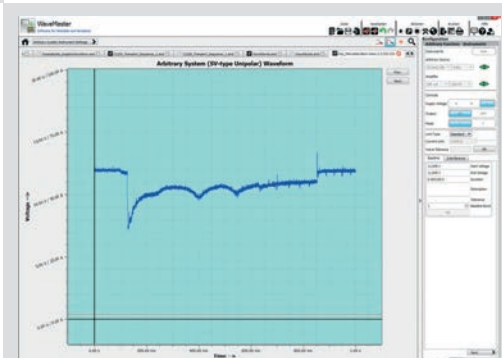

Imported real waveform out of an oscilloscope

# Automotive Standard LV124 (VW80000) E-01 ... E-16

One of the main standards in automotive industries is LV124 / VW80000. With these systems, this standard can be simulated easily. The waveform library contains all electronic waveform tests out of this specification.

For E-17 ... E-22 please ask for our fully automated Test System

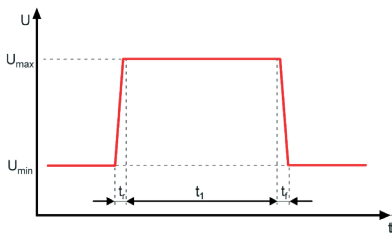

E-01 Long-term overvoltage

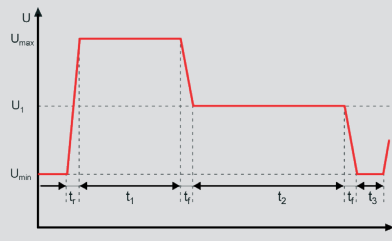

E-02 Transient overvoltage

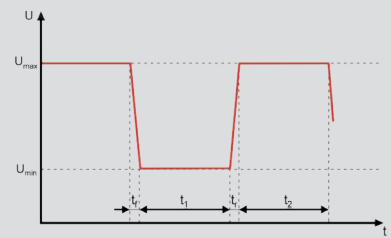

E-03 Transient undervoltage

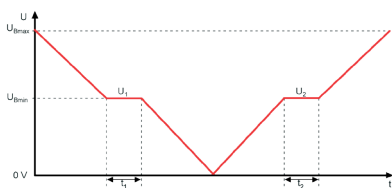

E-07 Slow decrease and increase of the supply voltage

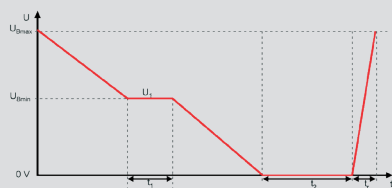

E-08 Slow decrease, quick increase of the supply voltage

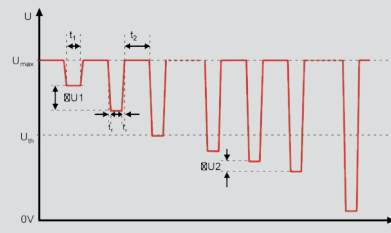

E-09 Reset behaviour

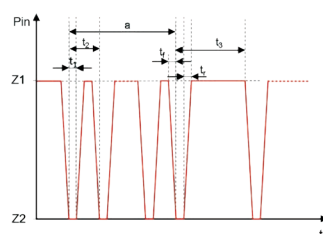

E-13 Pin interruption <sup>1)</sup>

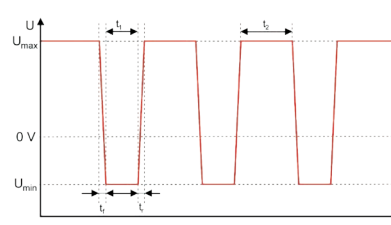

E-15 Reverse polarity (dynamic)

- 1) Additional electric switch necessary
- 2) Additional power supply necessary

# Other Standards such as LV148, ISO 16750, ISO 7637, DIN 40839, GS 95024, ..., Can Be Simulated Equally

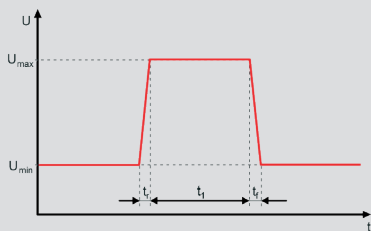

E-04 Jump start

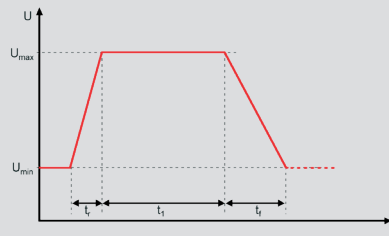

E-05 Load dump

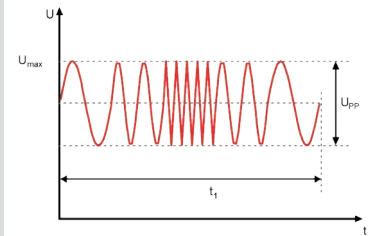

E-06 Superimposed alternating voltage

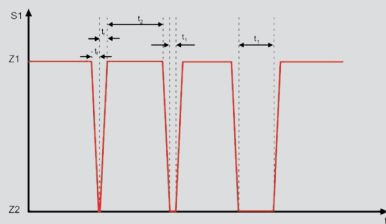

E-10 Short interruptions <sup>1)</sup>

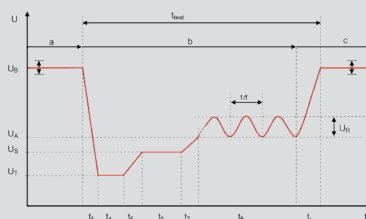

E-11 Start pulses

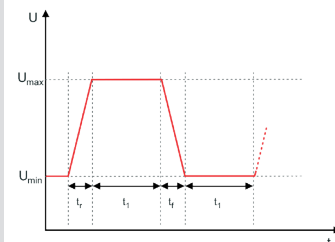

E-12 Voltage curve with intelligent generator control

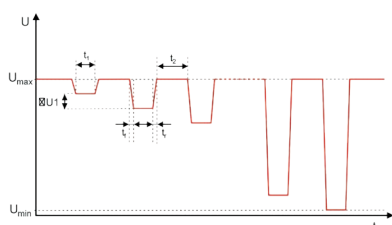

E-15 Reverse polarity (static)

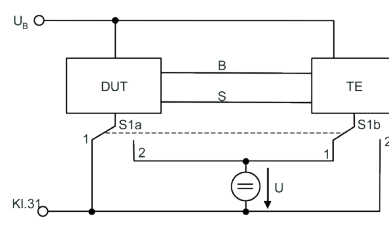

E-16 Ground offset <sup>2)</sup>

## Vehicle And Avionic Applications

The BOLAB arbitrary 4-quadrant amplifiers are predestined to simulate vehicle and avionic standards such as LV 124 / VW 80000, LV148, VDA 320, ISO 7637, DIN 40839, ISO 16750, GS 95024 and many other related norms.

These waveforms and also a wide range of company-specific car manufacturer standards (BMW, Daimler, VW, ...) are included in the standard package.

# High Voltage Superimposed Alternating Voltage LV123 / HV-09 / VW 80300

Series operation solution allows to test HV components up to 1000 V DC.  
Standards like LV123, ISO 3637-4 and many others can be tested.  
With our 4-quadrant amplifier systems, interferences up to 200 kHz with an amplitude of more than 40 V<sub>pp</sub> are possible.

## Our Solution

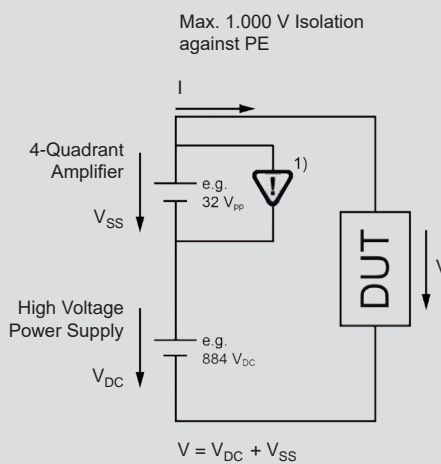

## Series Operation With Applied Voltage Ripple

Example:

$U_{DC} = 900 \text{ V}$   
 $U_{SS} = 32 \text{ V}_{pp}$   
 $f = 200 \text{ kHz}$   
 $I = \text{Depending on } I_{max} \text{ of the 100-TS instrument}$

## High Voltage Power Supply

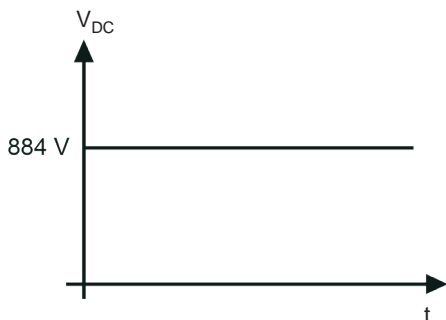

## 4-Quadrant Amplifier

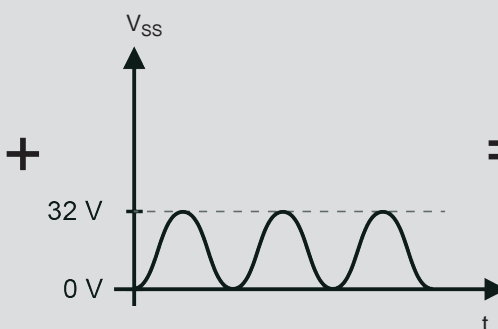

## High Voltage Power Supply + 4-Quadrant Amplifier

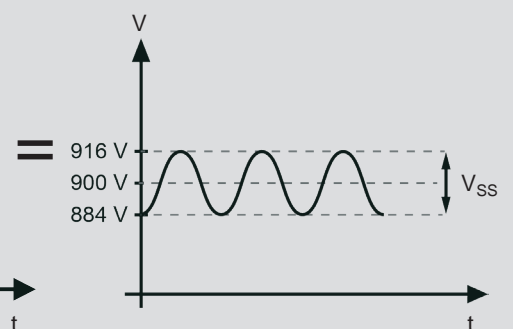

1) Option OVR HV necessary  
(Over voltage protection for high voltage power supply in series)

## How to define the diagrams.

Example:

$I = 100 \text{ A}, V = 450 \text{ V}, V_{pp} = 20 \text{ V}$   
 $P_{HV} = 450 \text{ V} \cdot 100 \text{ A} \rightarrow P_{HV} \sim 50 \text{ KW}$   
 $P_{4Q} = 20 \text{ V} \cdot 100 \text{ A} \rightarrow P_{4Q} \sim 2 \text{ KW}$   
 out of the voltage / current graphics and its voltage ranges, we need a 4-quadrant amplifier with approximately 3 KW.



# Variable Waveform Generation

## Variations In Voltage And Time

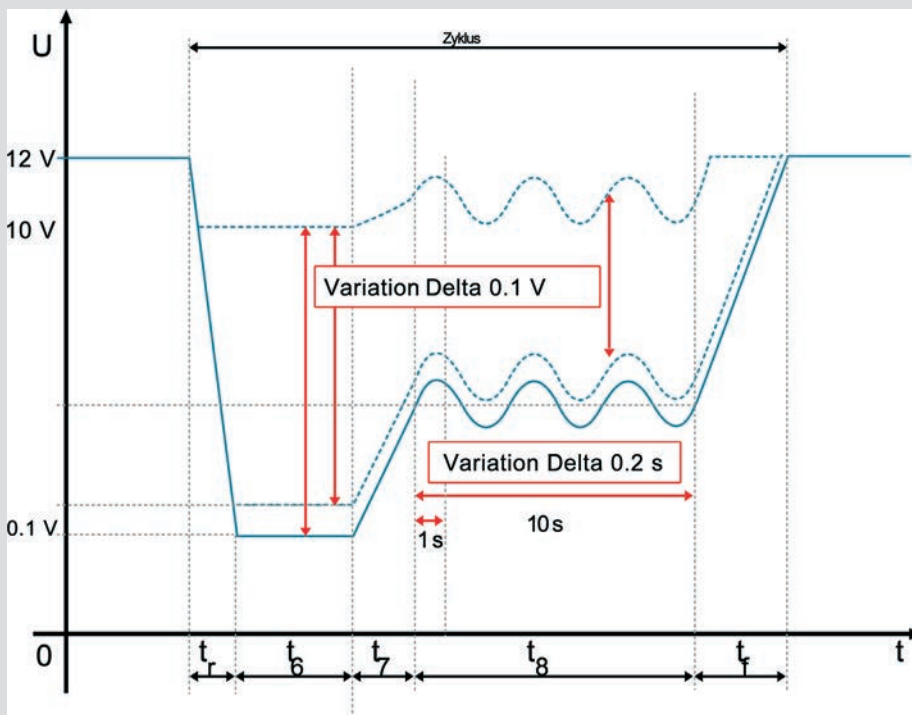

## Easy Definition Of Variations

Meanwhile, many car manufacturers extend the standard waveforms with many variable parameters in time and amplitude.

BOLAB's comprehensive WaveMaster Software allows to do these variations easily.

## Test System With Electronic Switch

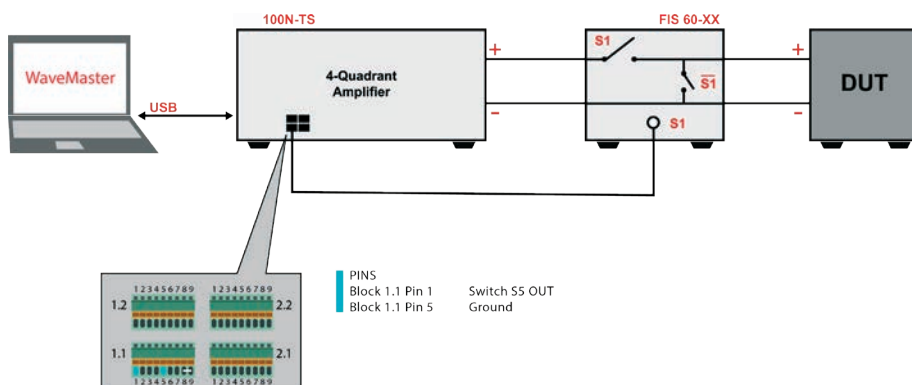

## E-10 / E-13 Pulses from LV124 standard

According to LV124, E-10 and E-13 pulses, interruptions need to be implemented. Hereby additional electronic switches are necessary. These switches are controlled by BOLAB's WaveMaster software and the amplifier's built-in counter outputs.

No additional function generator is necessary. This allows to build up a fully automated HIL test system.

# Easy Programming Python

## Special Features

- Ready to use for LabView™, Vector CANoe / CAPL, C#, C++, ANSI C, Python, etc.
- Creating waveforms out of source code
- Predefined commands for sine waves, exponential functions, ramps, etc.
- Integration into HIL simulation systems
- Complete interface handling and configuration
- Starting and closing software out of application

## Example 1

This programming example in Python opens an existing data file, loads data into amplifiers memory, switches the output on and runs the application in a loop of five times.

```
import WaveMaster_PY27_x32
import time

#Create PYD object
wavemaster = WaveMaster_PY27_x32.CreateObject()
#Connect to the WaveMaster server
serverIPAddress = „10.99.92.78“
serverPortNumber = 700
arbnct.Connect(serverIPAddress,serverPortNumber)

#Open an existing file
fileName = „F:\\Waveform1MV.and“
openfileRet = wavemaster.OpenFile(fileName)

#Arbitrary System Function
sys=WaveMaster.GetArbitrarySystem()
#Configure the device settings
#Define source and amplifier
source = „NI DAQ USB-6259“
amplifier = „BOLAB 105-75N-TS“
#Set System
setSysRet = sys.Set(1,source,amplifier,0,0,0)
time.sleep(5)
#Load waveform into instruments memory
sys.Load()
#Enable output
sys.Execute()
#Start runnings of waveform with burst=5
sys.Start(5)
#Wait until waveform ends after 5 runnings
run = sys.IsRun()
while run == 1:
    time.sleep(0.5)
    run = sys.IsRun()
#Set output to standby
sys.Standby()

#Close file
openfileRet.Close()
#Disconnect from WaveMaster server
wavemaster.disconnect()
```

# C++

## Example 2

Creating waveforms out of customers programming source code is quite easy:

```
using System;
using System.Collections.Generic;
using System.Linq;
using System.Text;
using WaveMaster_CPP_x32;

namespace TestCase2
{
    class Program
    {
        static void Main(string[] args)
        {
            //assuming WaveMaster is started externally in server mode
            RemoteWaveMasterDotNet _dllTest = new RemoteWaveMasterDotNet();
            Resource _sysResource = null;
            Resource _fileResNew = null;

            string ipAddress = „10.99.92.78“;
            int iport = 700;
            int res = -1;
            int layer = 1;
            string source = „NI DAQ USB-6259“;
            string amplifier = „BOLAB 105-75N-TS“;
            string online = string.Empty;
            string fileName = „F:\Waveform2MV.and“;
            int fileType = 0x10;
            int run = 0;

            res = _dllTest.Connect(ipAddress, iport);
            Console.WriteLine(„1 - Connected to WaveMaster...“);
            res = _dllTest.NewFile(ref _fileResNew, fileType, fileName);
            if(res == 0)
                Console.WriteLine(„2 - New File created...“);
            res = _dllTest.AddDataFile(_fileResNew,1,0.0,0.0,5.0);
            if(res == 0)
                Console.WriteLine(„ - 1 New value in waveform added...“);
            res = _dllTest.AddDataFile(_fileResNew,1,0.1,12.0,5.0);
            if(res == 0)
                Console.WriteLine(„ - 2 New value in waveform added...“);
            res = _dllTest.AddDataFile(_fileResNew,1,0.5,12.0,5.0,1,50.0,10.0,2.0,0.0,0.0);
            if(res == 0)
                Console.WriteLine(„ - 3 Sine interference on waveform added...“);
            res = _dllTest.AddDataFile(_fileResNew,1,1.0,0.0,5.0);
            if(res == 0)
                Console.WriteLine(„ - 4 New value in waveform added...“);
            res = _dllTest.GetArbitrarySystem(out _sysResource);
            if (res == 0)
            {
                Console.WriteLine(„3 - GetArbitrarySystem...“);
                res = _dllTest.SetSystem(_sysResource,ref online,layer,source,amplifier,0,0,0);
                if (res == 0)
                {
                    res = _dllTest.LoadSystem(_sysResource);
                    if (res == 0)
                        Console.WriteLine(„5 - Write Waveform into instruments memory...“);
                    res = _dllTest.ExecuteSystem(_sysResource);
                    if (res == 0)
                        Console.WriteLine(„6 - Switch instruments output on...“);
                    res = _dllTest.StartSystem(_sysResource, 5);
                    if (res == 0)
                        Console.WriteLine(„7 - Run waveform 5 times...“);
                    res = _dllTest.IsRunSystem(_sysResource, out run);
                    if (res == 0)
                        Console.WriteLine(„8 - IsRunSystem...“);
                    while (run == 1)
                    {
                        System.Threading.Thread.Sleep(1000);//1 sec
                        res = _dllTest.IsRunSystem(_sysResource, out run);
                    }
                    res = _dllTest.StandbySystem(_sysResource);
                    if (res == 0)
                        Console.WriteLine(„9 - StandbySystem...“);
                }
            }
            res = _dllTest.SaveFile(_fileResNew,fileName);
            res = _dllTest.CloseFile(_fileResNew);
            res = _dllTest.Disconnect();
        }
    }
}
```

## Example 2 As Graphic Waveform

This code in C# generates the following waveform and runs it 5 times.

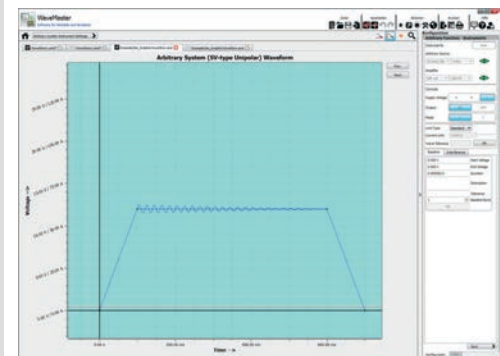

# Technical Data / Order Information

## 100-35N-TS

### 35 V / -16 V

#### Order Information

105-35N-TS	-16 V...+35 V / 20 A / 0,4 kW
110-35N-TS	-16 V...+35 V / 40 A / 1 kW
120-35N-TS	-16 V...+35 V / 76 A / 2 kW
130-35N-TS	-16 V...+35 V / 114 A / 3 kW
140-35N-TS	-16 V...+35 V / 152 A / 4 kW
150-35N-TS	-16 V...+35 V / 190 A / 5 kW
160-35N-TS	-16 V...+35 V / 228 A / 6 kW
180-35N-TS	-16 V...+35 V / 304 A / 8 kW
200-35N-TS	-16 V...+35 V / 380 A / 10 kW
220-35N-TS	-16 V...+35 V / 456 A / 12 kW
250-35N-TS	-16 V...+35 V / 570 A / 15 kW
280-35N-TS	-16 V...+35 V / 684 A / 18 kW

#### Technical Specifications

Ranges / Current	105-35N-TS	110-35N-TS	120-35N-TS	130-35N-TS	140-35N-TS	150-35N-TS
Low voltage range -16 V...+16 V	15 A	38 A	76 A	114 A	152 A	190 A
Middle voltage range -16 V...+27 V	15 A	38 A	76 A	114 A	152 A	190 A
High voltage range -16 V...+35 V	11 A	28 A	55 A	83 A	110 A	138 A
Current peak 500 ms	2 x I <sub>MAX</sub>					
Gain (voltage)	1 V / 10 V					
Gain (current)	1 V / 2,5 A	1 V / 10 A	1 V / 100 A			
DC-Offset	< 1 mV					
Monitor output (voltage)	1 V / 10 V					
Monitor output (current)	1 V / 2,5 A	1 V / 10 A	1 V / 100 A			
Residual Noise	< 7 mV					
Source power	400 W	1.000 W	2.000 W	3.000 W	4.000 W	5.000 W
Sink power	140 W	350 W	700 W	1.050 W	1.400 W	1.750 W
Slew rate	100 V / $\mu$ s		50 V / $\mu$ s			
CV mode	DC - 1 MHz  DC - 200 kHz DC - 500 kHz  Depending on RC network					
Frequency						
full range						
small signal (-3 dB)						
CC mode	DC - 1 MHz  DC - 200 kHz DC - 500 kHz  Depending on RC network					
Frequency						
full range						
small signal (-3 dB)						
Input impedance	100 k $\Omega$					
unbalanced, 1 kHz	200 k $\Omega$					
balanced, 1 kHz						
Instrument size	19", 3 U	19", 4 U	19", 12 U	19", 16 U	19", 20 U	19", 24 U
Dimensions WxHxD (cm)						
Delivery	Instrument	Instrument	19" rack	19" rack	19" rack	19" rack
Weight	20 kg	40 kg	150 kg	190 kg	230 kg	270 kg
Power supply	230 V AC ( $\pm$ 10%, 50 Hz ... 60 Hz)			3 x 230 V AC ( $\pm$ 10%, 50 Hz ... 60 Hz)		
Protection	10 A		3 x 16 A			
Protective functions	OVT, OCT, OTP					
Operating temperature	10° C - 55° C					

## Technical Specifications

Ranges / Current	160-35N-TS	180-35N-TS	200-35N-TS	220-35N-TS	250-35N-TS	280-35N-TS					
Low voltage range -16 V...+16 V	228 A	304 A	380 A	456 A	570 A	684 A					
Middle voltage range -16 V...+27 V	228 A	304 A	380 A	456 A	570 A	684 A					
High voltage range -16 V...+35 V	165 A	220 A	276 A	331 A	413 A	496 A					
Current peak 500 ms	2 x I <sub>MAX</sub>										
Gain (voltage)	1 V / 10 V										
Gain (current)	1 V / 100 A										
DC-Offset	< 1 mV										
Monitor output (voltage)	1 V / 10 V										
Monitor output (current)	1 V / 100 A										
Residual Noise	< 7 mV										
Source power	6.000 W	8.000 W	10.000 W	12.000 W	15.000 W	18.000 W					
Sink power	2.100 W	2.800 W	3.500 W	4.200 W	5.200 W	6.300 W					
Slew rate	50 V / $\mu$ s										
CV mode											
Frequency											
full range							DC - 200 kHz				
small signal (-3 dB)							DC - 500 kHz				
CC mode											
Frequency											
full range							Depending on RC network				
small signal (-3 dB)											
Input impedance unbalanced, 1 kHz balanced, 1 kHz	100 k $\Omega$ 200 k $\Omega$										
Instrument size	19", 28 U	2x 19", 20 U	2 x 19", 24 U	2 x 19", 28 U	3 x 19", 24 U	3 x 19", 28 U					
Dimensions WxHxD (cm)											
Delivery	19" rack	2 x 19" rack	2 x 19" rack	2 x 19" rack	3 x 19" rack	3 x 19" rack					
Weight	310 kg	2 x 230 kg	2 x 270 kg	2 x 310 kg	2 x 270 kg	2 x 310 kg					
Power supply	3 x 230 V AC ( $\pm$ 10%, 50 Hz ... 60 Hz)										
Protection	3 x 16 A										
Protective functions	OVT, OCT, OTP										
Operating temperature	10° C - 55° C										

## Options

100S	Sensing (0 V / 0,5 V / 1 V / 2 V) standard in systems > 1 KW
100I3	3-channel isolation amplifier
100VR	Variable internal resistor 0...200 m $\Omega$
100CS200	Current sensor (standard in systems > 1 KW)
OVR HV	Over voltage protection for high voltage power supply in series
100K	Compensation network to run as current amplifier
100MW3	19" Adapter for 3U systems
100MW4	19" Adapter for 4U systems
FIS 60-75	Electronic switch (60 V / 75 A)
FIS 60-125	Electronic switch (60 V / 125 A)
FIS 60-CS	Cable Set for electronic switch
FIS 60-RR	Reference resistors (1 $\Omega$ / 100 $\Omega$ / 1k $\Omega$ )
700-XX	19" rack

# Technical Data / Order Information

## 100-70N-TS

### 70 V / -16 V

#### Order Information

105-70N-TS	-16 V...+70 V /	20 A / 0,5 kW
110-70N-TS	-16 V...+70 V /	40 A / 1 kW
120-70N-TS	-16 V...+70 V /	76 A / 2 kW
130-70N-TS	-16 V...+70 V /	114 A / 3 kW
140-70N-TS	-16 V...+70 V /	152 A / 4 kW
150-70N-TS	-16 V...+70 V /	190 A / 5 kW
160-70N-TS	-16 V...+70 V /	228 A / 6 kW
180-70N-TS	-16 V...+70 V /	304 A / 8 kW
200-70N-TS	-16 V...+70 V /	380 A / 10 kW
220-70N-TS	-16 V...+70 V /	456 A / 12 kW
250-70N-TS	-16 V...+70 V /	570 A / 15 kW
280-70N-TS	-16 V...+70 V /	684 A / 18 kW

#### Technical Specifications

Ranges / Current	105-70N-TS	110-70N-TS	120-70N-TS	130-70N-TS	140-70N-TS	150-70N-TS
Low voltage range -16 V...+16 V	19 A	38 A	76 A	114 A	152 A	190 A
Middle voltage range -16 V...+27 V	19 A	38 A	76 A	114 A	152 A	190 A
High voltage range -16 V...+70 V	7 A	14 A	29 A	43 A	57 A	71 A
Current peak 500 ms	2 x I <sub>MAX</sub>					
Gain (voltage)	1 V / 10 V					
Gain (current)	1 V / 2,5 A	1 V / 10 A	1 V / 100 A			
DC-Offset	< 1 mV					
Monitor output (voltage)	1 V / 10 V					
Monitor output (current)	1 V / 2,5 A	1 V / 10 A	1 V / 100 A			
Residual Noise	< 7 mV					
Source power	500 W	1.000 W	2.000 W	3.000 W	4.000 W	5.000 W
Sink power	240 W	470 W	940 W	1.400 W	1.800 W	2.400 W
Slew rate	100 V / $\mu$ s		50 V / $\mu$ s			
CV mode	DC - 1 MHz					
Frequency full range small signal (-3 dB)						
CC mode	Depending on RC network					
Frequency full range small signal (-3 dB)						
Input impedance unbalanced, 1 kHz balanced, 1 kHz	100 k $\Omega$ 200 k $\Omega$					
Instrument size	19", 3 U	19", 4 U	19", 12 U	19", 16 U	19", 20 U	19", 24 U
Dimensions WxHxD (cm)						
Delivery	Instrument	Instrument	19" rack	19" rack	19" rack	19" rack
Weight	20 kg	40 kg	150 kg	190 kg	230 kg	270 kg
Power supply	230 V AC ( $\pm$ 10%, 50 Hz ... 60 Hz)		3 x 230 V AC ( $\pm$ 10%, 50 Hz ... 60 Hz)			
Protection	10 A		3 x 16 A			
Protective functions	OVT, OCT, OTP					
Operating temperature	10° C - 55° C					

## Technical Specifications

Ranges / Current	160-70N-TS	180-70N-TS	200-70N-TS	220-70N-TS	250-70N-TS	280-70N-TS
Low voltage range -16 V...+16 V	228 A	304 A	380 A	456 A	570 A	684 A
Middle voltage range -16 V...+27 V	228 A	304 A	380 A	456 A	570 A	684 A
High voltage range -16 V...+70 V	86 A	114 A	143 A	171 A	214 A	257 A
Current peak 500 ms	2 x I <sub>MAX</sub>					
Gain (voltage)	1 V / 10 V					
Gain (current)	1 V / 100 A					
DC-Offset	< 1 mV					
Monitor output (voltage)	1 V / 10 V					
Monitor output (current)	1 V / 100 A					
Residual Noise	< 7 mV					
Source power	6.000 W	8.000 W	10.000 W	12.000 W	15.000 W	18.000 W
Sink power	2.800 W	3.800 W	4.700 W	5.600 W	7.000 W	8.400 W
Slew rate	50 V / μs					
CV mode	DC - 200 kHz DC - 500 kHz					
Frequency full range small signal (-3 dB)						
CC mode	Depending on RC network					
Frequency full range small signal (-3 dB)						
Input impedance unbalanced, 1 kHz balanced, 1 kHz	100 k Ω 200 k Ω					
Instrument size	19", 28 U	2x 19", 20 U	2 x 19", 24 U	2 x 19", 28 U	3 x 19", 24 U	3 x 19", 28 U
Dimensions WxHxD (cm)						
Delivery	19" rack	2 x 19" rack	2 x 19" rack	2 x 19" rack	3 x 19" rack	3 x 19" rack
Weight	310 kg	2 x 230 kg	2 x 270 kg	2 x 310 kg	2 x 270 kg	2 x 310 kg
Power supply	3 x 230 V AC (±10%, 50 Hz ... 60 Hz)					
Protection	3 x 16 A					
Protective functions	OVT, OCT, OTP					
Operating temperature	10° C - 55° C					

## Options

100S	Sensing (0 V / 0,5 V / 1 V / 2 V) standard in systems > 1 KW
100I3	3-channel isolation amplifier
100VR	Variable internal resistor 0...200 mΩ
100CS200	Current sensor (standard in systems > 1 KW)
OVR HV	Over voltage protection for high voltage power supply in series
100K	Compensation network to run as current amplifier
100MW3	19" Adapter for 3U systems
100MW4	19" Adapter for 4U systems
FIS 60-75	Electronic switch (60 V / 75 A)
FIS 60-125	Electronic switch (60 V / 125 A)
FIS 60-CS	Cable Set for electronic switch
FIS 60-RR	Reference resistors (1Ω / 100Ω / 1kΩ)
700-XX	19" rack

# Technical Data / Order Information

## 100-75N-TS

### 75 V / -75 V

#### Order Information

105-75N-TS	-75 V...+75 V /	20 A / 0,5 kW
110-75N-TS	-75 V...+75 V /	40 A / 1 kW
120-75N-TS	-75 V...+75 V /	76 A / 2 kW
130-75N-TS	-75 V...+75 V /	114 A / 3 kW
140-75N-TS	-75 V...+75 V /	152 A / 4 kW
150-75N-TS	-75 V...+75 V /	190 A / 5 kW
160-75N-TS	-75 V...+75 V /	228 A / 6 kW
180-75N-TS	-75 V...+75 V /	304 A / 8 kW
200-75N-TS	-75 V...+75 V /	380 A / 10 kW
220-75N-TS	-75 V...+75 V /	456 A / 12 kW
250-75N-TS	-75 V...+75 V /	570 A / 15 kW
280-75N-TS	-75 V...+75 V /	684 A / 18 kW

#### Technical Specifications

Ranges / Current	105-75N-TS	110-75N-TS	120-75N-TS	130-75N-TS	140-75N-TS	150-75N-TS
Low voltage range -25 V...+25 V	19 A	38 A	76 A	114 A	152 A	190 A
Middle voltage range -50 V...+50 V	10 A	19 A	38 A	57 A	76 A	95 A
High voltage range -75 V...+75 V	7 A	14 A	27 A	40 A	53 A	67 A
Current peak 500 ms	2 x I <sub>MAX</sub>					
Gain (voltage)	1 V / 10 V					
Gain (current)	1 V / 2,5 A	1 V / 10 A	1 V / 100 A			
DC-Offset	< 1 mV					
Monitor output (voltage)	1 V / 10 V					
Monitor output (current)	1 V / 2,5 A	1 V / 10 A	1 V / 100 A			
Residual Noise	< 7 mV					
Source power	500 W	1.000 W	2.000 W	3.000 W	4.000 W	5.000 W
Sink power	500 W	1.000 W	2.000 W	3.000 W	4.000 W	5.000 W
Slew rate	100 V / $\mu$ s		50 V / $\mu$ s			
CV mode	DC - 1 MHz		DC - 200 kHz		DC - 500 kHz	
Frequency full range small signal (-3 dB)						
CC mode	Depending on RC network					
Frequency full range small signal (-3 dB)						
Input impedance unbalanced, 1 kHz balanced, 1 kHz	100 k $\Omega$ 200 k $\Omega$					
Instrument size	19", 3 U	19", 4 U	19", 12 U	19", 16 U	19", 20 U	19", 24 U
Dimensions WxHxD (cm)						
Delivery	Instrument	Instrument	19" rack	19" rack	19" rack	19" rack
Weight	20 kg	40 kg	150 kg	190 kg	230 kg	270 kg
Power supply	230 V AC ( $\pm$ 10%, 50 Hz ... 60 Hz)		3 x 230 V AC ( $\pm$ 10%, 50 Hz ... 60 Hz)			
Protection	10 A		3 x 16 A			
Protective functions	OVT, OCT, OTP					
Operating temperature	10° C - 55° C					



## Technical Specifications

Ranges / Current	160-75N-TS	180-75N-TS	200-75N-TS	220-75N-TS	250-75N-TS	280-75N-TS
Low voltage range -25 V...+25 V	228 A	304 A	380 A	456 A	570 A	684 A
Middle voltage range -50 V...+50 V	114 A	152 A	190 A	228 A	285 A	342 A
High voltage range -75 V...+75 V	80 A	106 A	133 A	160 A	200 A	240 A
Current peak 500 ms	2 x I <sub>MAX</sub>					
Gain (voltage)	1 V / 10 V					
Gain (current)	1 V / 100 A					
DC-Offset	< 1 mV					
Monitor output (voltage)	1 V / 10 V					
Monitor output (current)	1 V / 100 A					
Residual Noise	< 7 mV					
Source power	6.000 W	8.000 W	10.000 W	12.000 W	15.000 W	18.000 W
Sink power	6.000 W	8.000 W	10.000 W	12.000 W	15.000 W	18.000 W
Slew rate	50 V / μs					
CV mode	DC - 200 kHz DC - 500 kHz					
Frequency full range small signal (-3 dB)						
CC mode	Depending on RC network					
Frequency full range small signal (-3 dB)						
Input impedance unbalanced, 1 kHz balanced, 1 kHz	100 k Ω 200 k Ω					
Instrument size	19", 28 U	2x 19", 20 U	2 x 19", 24 U	2 x 19", 28 U	3 x 19", 24 U	3 x 19", 28 U
Dimensions WxHxD (cm)						
Delivery	19" rack	2 x 19" rack	2 x 19" rack	2 x 19" rack	3 x 19" rack	3 x 19" rack
Weight	310 kg	2 x 230 kg	2 x 270 kg	2 x 310 kg	2 x 270 kg	2 x 310 kg
Power supply	3 x 230 V AC (±10%, 50 Hz ... 60 Hz)					
Protection	3 x 16 A					
Protective functions	OVT, OCT, OTP					
Operating temperature	10° C - 55° C					

## Options

100S	Sensing (0 V / 0,5 V / 1 V / 2 V) standard in systems > 1 KW
100I3 100VR	3-channel isolation amplifier Variable internal resistor 0...200 mΩ
100CS200	Current sensor (standard in systems > 1 KW)
OVR HV	Over voltage protection for high voltage power supply in series
100K	Compensation network to run as current amplifier
100MW3	19" Adapter for 3U systems
100MW4	19" Adapter for 4U systems
FIS 60-75	Electronic switch (60 V / 75 A)
FIS 60-125	Electronic switch (60 V / 125 A)
FIS 60-CS	Cable Set for electronic switch
FIS 60-RR	Reference resistors (1Ω / 100Ω / 1kΩ)
700-XX	19" rack

## Scope Of Supply

**Amplifier system**  
 Power cord  
 User manual  
 WaveMaster software  
 WaveMaster remote DLL's  
 Waveform library  
 19" rack (systems > 1 KW)

Sales Partner:



**ABSOLUTE EMC** LLC.  
Covering sales in North America  
United States, Mexico, & Canada

absolute-emc.com  
Phone: 703-774-7505  
info@absolute-emc.com

**BOLAB Systems GmbH**

Muehlstetten 3  
72351 Geislingen  
Germany

e-mail            [Info@BOLAB-Systems.com](mailto:Info@BOLAB-Systems.com)  
Internet         [www.BOLAB-Systems.com](http://www.BOLAB-Systems.com)

